

NAD

T532/T512

DVD / CD / MP3 Player

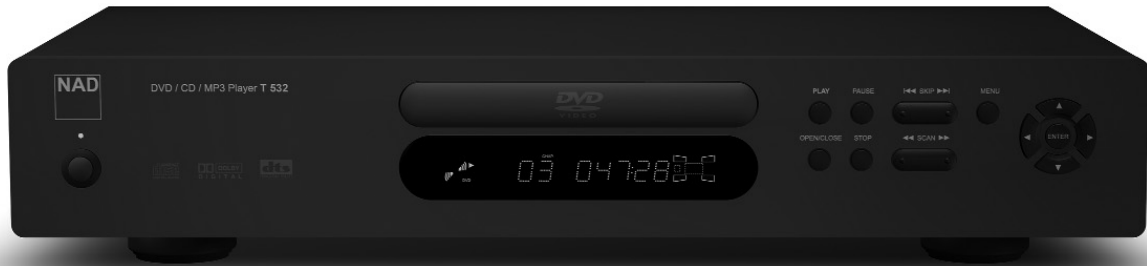

GB

Owner's Manual

WARNING : TO REDUCE THE RISK OF FIRE OR ELECTRIC SHOCK, DO NOT EXPOSE THIS PRODUCT TO RAIN OR MOISTURE

CAUTION

THIS DVD RECEIVER EMPLOYS A LASER SYSTEM.

TO ENSURE PROPER USE OF THIS PRODUCT, PLEASE READ THIS OWNER'S MANUAL CAREFULLY AND RETAIN FOR FUTURE REFERENCE, SHOULD THE UNIT REQUIRE MAINTENANCE, CONTACT AN AUTHORIZED SERVICE LOCATION-SEE SERVICE PROCEDURE.

USE OF CONTROLS, ADJUSTMENTS OR THE PERFORMANCE OF PROCEDURES OTHER THAN THOSE SPECIFIED MAY RESULT IN HAZARDOUS RADIATION EXPOSURE.

TO PREVENT DIRECT EXPOSURE TO LASER BEAM, DO NOT TRY TO OPEN THE ENCLOSURE. VISIBLE LASER RADIATION WHEN OPEN THE ENCLOSURE. DO NOT STARE INTO BEAM.

THE APPARATUS SHALL NOT BE EXPOSED TO DRIPPING OR SPLASHING AND THAT NO OBJECTS FILLED WITH LIQUIDS, SUCH AS VASES, SHALL BE PLACED ON THE APPARATUS.

WARNING : CHANGES OR MODIFICATIONS NOT EXPRESSLY APPROVED BY THE PARTY RESPONSIBLE FOR COMPLIANCE COULD VOID THE USER'S AUTHORITY TO OPERATE THE EQUIPMENT.

RECORD YOUR MODEL NUMBER (NOW, WHILE YOU CAN SEE IT)

The model and serial number of your new DVD player are located on the back of the DVD player cabinet. For your future convenience, we suggest that you record these numbers here:



MODEL NO. _____
SERIAL NO. _____



This product is manufactured to comply with the radio interference requirements of EEC DIRECTIVE 89/336/EEC, 93/68/EEC and 73/23/EEC.

INTRODUCTION	
Safety Precautions	2
Table of Contents	3
Identification of Controls	4-7
Front Panel/Display window	4
Rear Panel	5
Remote Control	6
Preparing the Remote Control	7
Operating with the Remote Control	7
Notes on Discs	8
CONNECTIONS	
Connecting to Surround Sound System.	9-11
Enjoying Dolby Digital Sound	9
Enjoying Dolby Pro Logic Surround Sound	10
Enjoying 2 Channel Digital Stereo Sound	11
Enjoying DTS Sound	11
Connecting to an Stereo System	12
Connecting to a TV	13
INITIAL SETTINGS	
Selection of initial settings	14
Selecting disc Languages	15
Selecting rating level and password	16-17
Selecting Country Code	17
Selecting TV Aspect	18
Selecting Menu Language	19
Selecting Digital Audio Output	20
Others	21
Table of Languages and Their Abbreviations	22
Table of Country Codes and Their Abbreviations	22
BASIC OPERATIONS	
Basic Playback	23-24
Special Playback	25-26
Still Picture	25
Frame Advance	25
Skipping chapters and tracks forward or back	25
Scanning at High Speed	26
Playing in Slow-Motion	26
OPERATION USING (GRAPHICAL USER INTERFACE) MENU ICONS	
General Information about GUI menu icons	27
Detailed description of each GUI menu icon	28
ADVANCED OPERATION	
Using a title menu	29
Using a DVD menu	29
Memorizing Settings for Viewed DVDs (Last Condition Memory)	30
Changing subtitle language	31
Changing audio soundtrack language	31
Viewing from another angle	32
Producing a 3D Surround effect	32
Repeat Play	33
Storing markers in memory to be viewed (listened to) again	34
Zoom Feature	35
Random Play	35
Program Play	36
Playback with MP3	37-38
REFERENCE	
Disc Requirements/Copyright Information	39
Before Calling Service Personnel	40
Specifications	41



MP3



GB

Introduction

IDENTIFICATION OF CONTROLS

FRONT PANEL

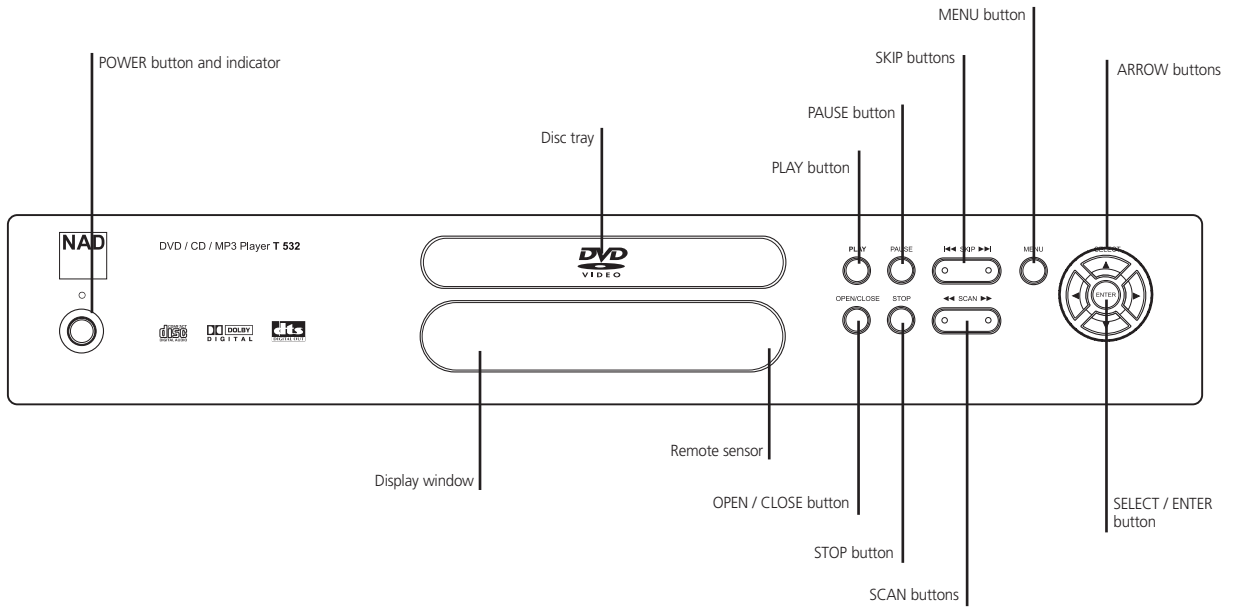

DISPLAY WINDOW

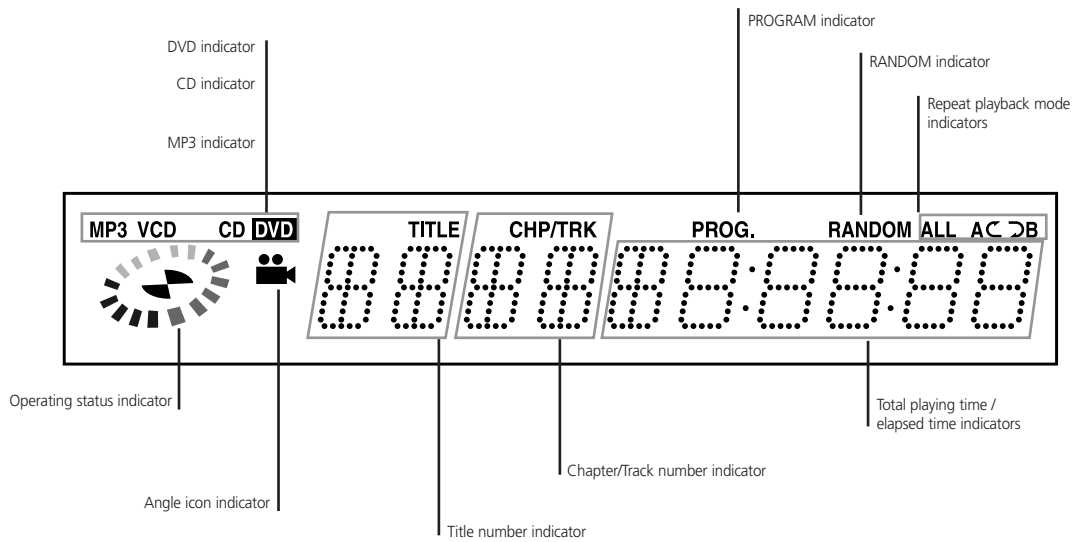

REAR PANEL

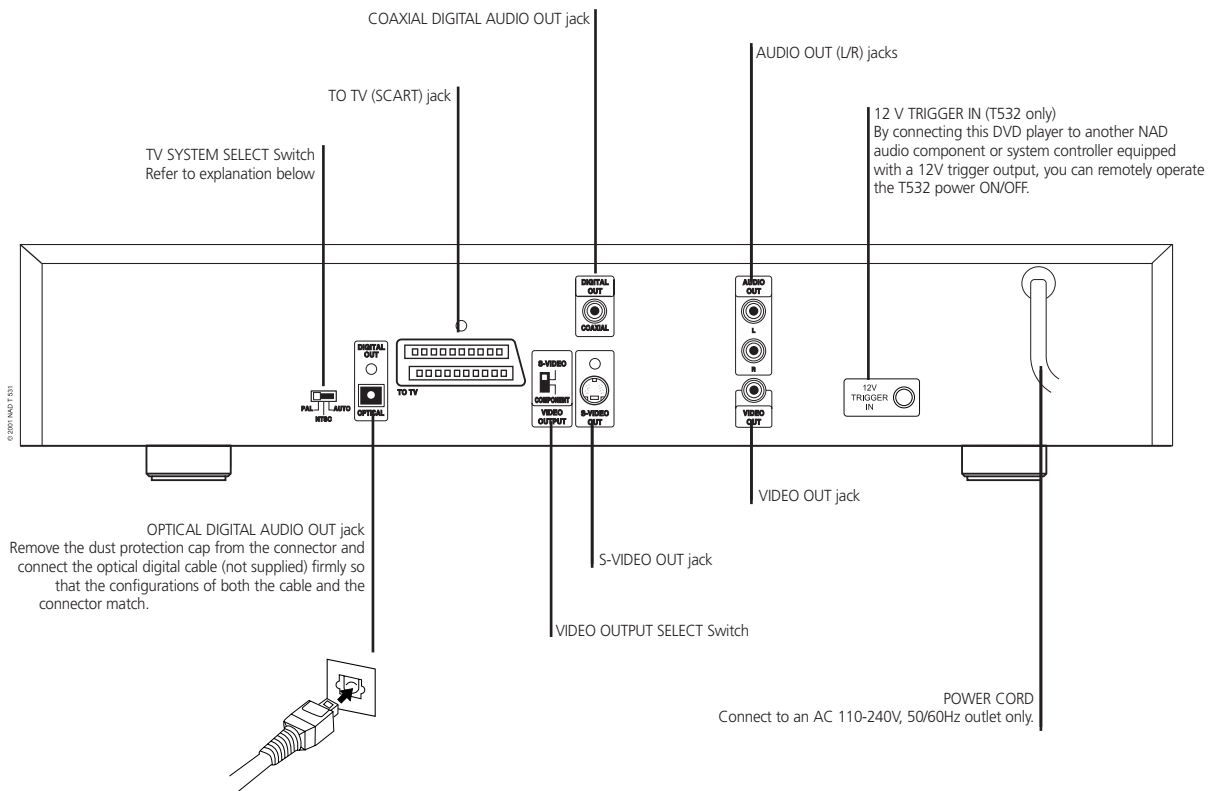

TV SYSTEM SELECT

You can enjoy NTSC or PAL discs by using your TV SYSTEM SELECT switch to choose the appropriate system.

If you try to play back PAL disc with NTSC-TV. The player will not playback the disc.

When the selected TV SYSTEM SELECT switch does not coincide with the system of your TV, normal colour picture may not be displayed.

Select the TV SYSTEM SELECT switch when the power is turned off.

When you playback NTSC disc with PAL-TV, some discs may produce black bands at the top and bottom of the screen.

Position of TV SYSTEM SELECT switch	Connected TV	Available disc
PAL	PAL	NTSC/PAL DVD disc
NTSC	NTSC	NTSC DVD disc
AUTO	MULTI SYSTEM TV	NTSC/PAL DVD disc



Introduction

IDENTIFICATION OF CONTROLS

REMOTE CONTROL

You will find instructions for each of the remote control function in the appropriate sections of this instruction manual

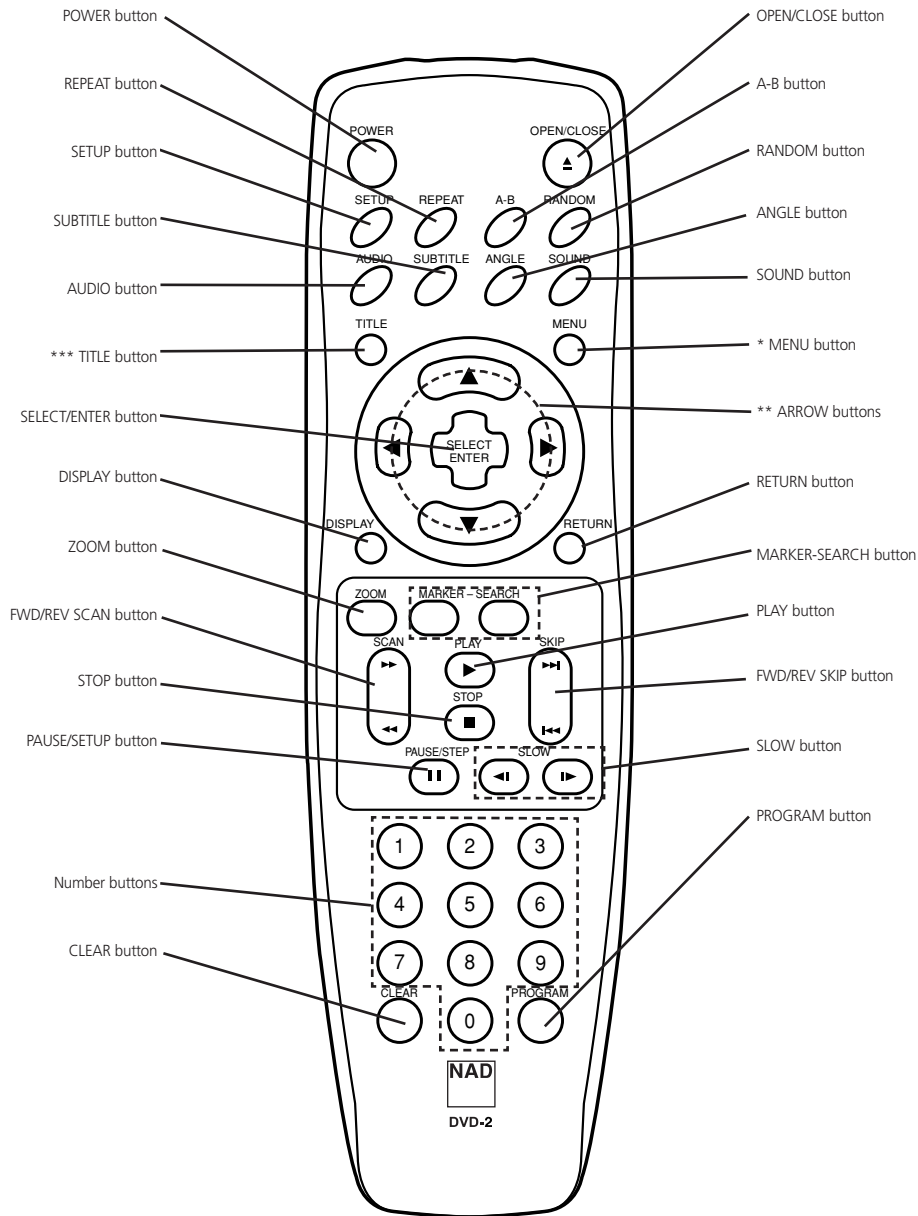

*MENU BUTTON

Use the MENU button to display the menu screen included on DVD video discs. To operate a menu screen, follow the instructions in Using a DVD Menu (page 29).

** DIRECTIONAL ARROW BUTTONS

(up, down, left, right) for use in high-lighting a selection on a GUI menu screen, TITLE and MENU screen.

***TITLE BUTTON

Use the TITLE button to display the title screen included on DVD video discs. To operate a menu screen, follow the instructions in Using a Title Menu (page 29).

PREPARING THE REMOTE CONTROL

Insert the batteries into the remote control so you can use it to operate the DVD player.

1 Open the battery cover

2 Insert batteries (AAA size)

- Make sure to match the + and - on the batteries to the marks inside the battery compartment.

3 Close the cover

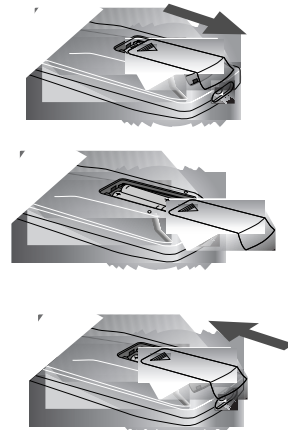

NOTES ON BATTERIES

- Improper use of batteries may cause battery leakage and corrosion.
- To operate the remote control correctly, follow the instructions.
- Do not insert the batteries into the remote control in the wrong direction.
- Do not charge, heat, open, or short-circuit the batteries.
- Do not throw the batteries into fire.
- Do not leave dead or exhausted batteries in the remote control.
- Do not use different types of batteries together, or mix old and new batteries.
- If you do not use the remote control for a long period of time, remove the batteries to avoid possible damage from battery corrosion.
- If the remote control does not function correctly or if the operating range becomes reduced, replace all batteries with new ones.
- If battery leakage occurs, wipe the battery liquid from the battery compartment, then insert new batteries.
- The batteries should last about one year with normal use.

OPERATING WITH THE REMOTE CONTROL

This section shows you how to use the remote control.

Point the remote control at the remote control sensor and press the buttons.

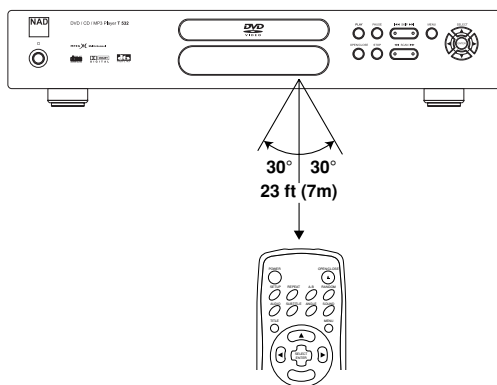

Distance: About 23 ft (7 m) from the front of the remote sensor

Angle: About 30 in each direction of the front of the remote sensor

- Do not expose the remote sensor of the DVD player to a strong light source such as direct sunlight or illumination. If you do so, you may not be able to operate the DVD player with the remote control.

NOTES ON THE REMOTE CONTROL

- Point the remote control at the remote sensor on the DVD player.
- Do not drop or give the remote control a shock.
- Do not leave the remote control near an extremely hot or humid place.
- Do not spill water or put anything wet on the remote control.
- Do not disassemble the remote control.



Introduction

NOTES ON DISCS

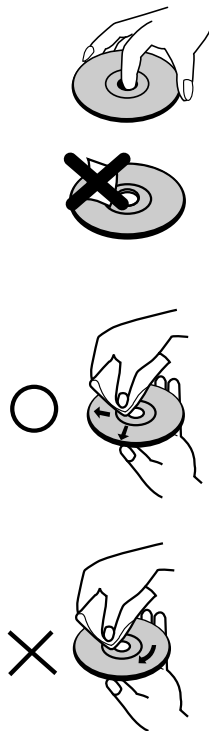

This section shows you how to handle, clean and store discs.

ON HANDLING DISCS

- Do not touch the playback side of the disc.
- Do not attach paper or tape to discs.

ON CLEANING DISCS

- Fingerprints and dust on the disc cause picture and sound deterioration. Wipe the disc from the centre outward with a soft cloth. Always keep the disc clean.
- If you cannot wipe off the dust with a soft cloth, wipe the disc lightly with a slightly moistened soft cloth and finish with a dry cloth.
- Do not use any type of solvents such as thinner, benzene, commercially available cleaners or anti-static spray for vinyl LPs. They may damage the disc.

ON STORING DISCS

- Do not store discs in a place subject to direct sunlight or near heat sources.
- Do not store discs in places subject to moisture and dust such as a bathroom or near a humidifier.
- Store discs vertically in a case. Stacking or placing objects on discs outside of their case may cause warping.

ABOUT THIS OWNER'S MANUAL

This owner's manual explains the basic instructions of this DVD player.

Some DVD video discs have functions that may not be explained in this owner's manual. Therefore, some instructions may differ from this owner's manual, and there may be extra instructions. In this case, follow the instructions displayed on the TV screen or package.

⊗ may appear on the TV screen during operation. This icon means the function explained in this owner's manual is not available on that specific DVD video disc.

CONNECTING TO THE SURROUND SOUND SYSTEM

ENJOYING DOLBY DIGITAL SOUND

You can enjoy the high quality dynamic sound of Dolby Digital, Dolby Pro Logic and 2 Channel Digital Stereo.

DOLBY DIGITAL

Dolby Digital is the surround sound technology used in theatres showing the latest movies, and is now available to reproduce this realistic effect in the home. You can enjoy motion picture and live concert DVD video discs by connecting the DVD player to a 5.1 channel receiver equipped with a Dolby Digital decoder or Dolby Digital processor.

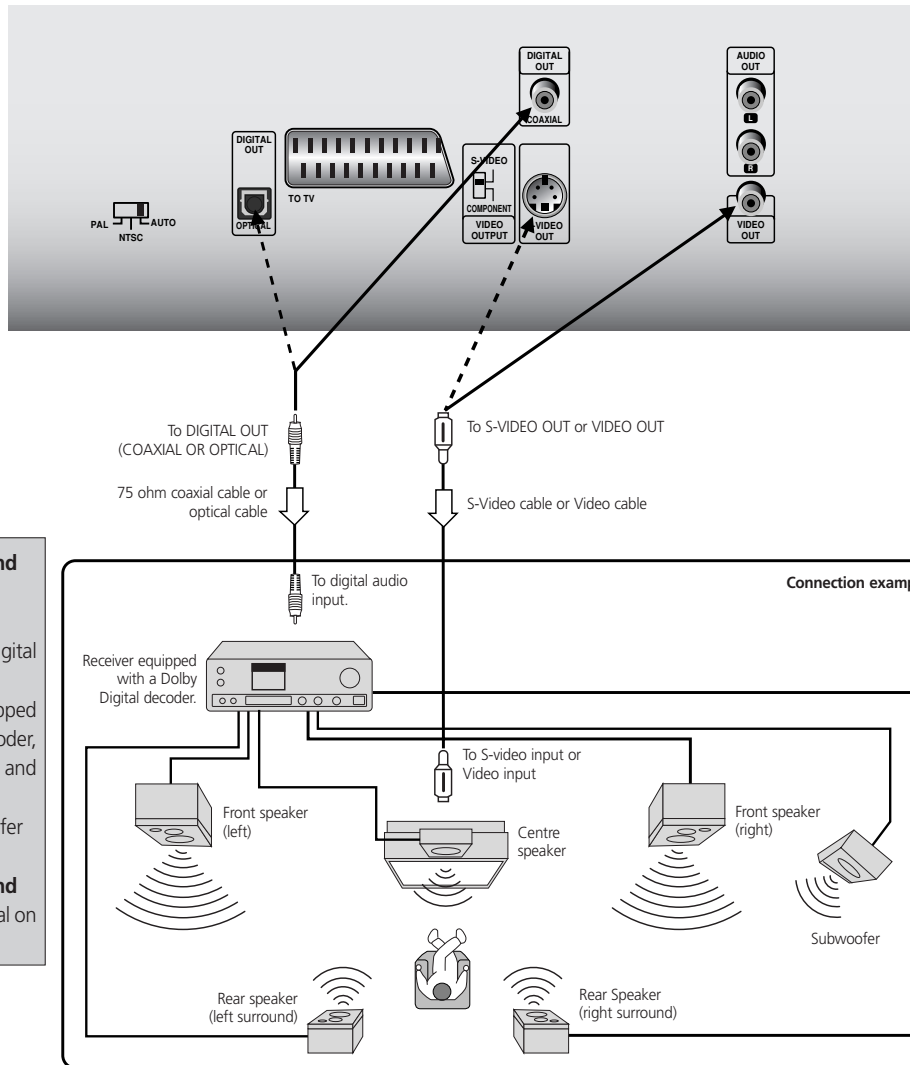

To enjoy Dolby Digital sound from this DVD player you need the following:

- DVD recorded in Dolby Digital 5.1
- 5.1 channel receiver equipped with a Dolby Digital decoder, or Dolby Digital processor and power amplifier
- 5 speakers and 1 sub woofer

To enjoy Dolby Digital sound

You need to select Dolby Digital on the SETUP menu

NOTES

- Refer to the owner's manual of your audio equipment as well.
- When you connect the DVD player to other equipment, be sure to turn off the power and unplug all of the equipment from the wall outlet before making any connections.
- The output sound of the DVD player has a wide dynamic range. Be sure to adjust the receiver's volume to a moderate listening level. Otherwise, the speakers may be damaged by a sudden high volume sound.
- Turn off the receiver before you connect or disconnect the DVD player's power cord. If you leave the receiver power on, the speakers may be damaged.

Manufactured under license from Dolby Laboratories.

Dolby, Pro Logic, and the double-D symbol are trademarks of Dolby Laboratories. Confidential Unpublished works. Copyright 1992-1997 Dolby Laboratories. All rights reserved.

Connections

CONNECTING TO THE SURROUND SOUND SYSTEM

ENJOYING DOLBY PRO LOGIC SURROUND SOUND

If your AV receiver has a Dolby Pro Logic decoder, refer to the following connection diagram.

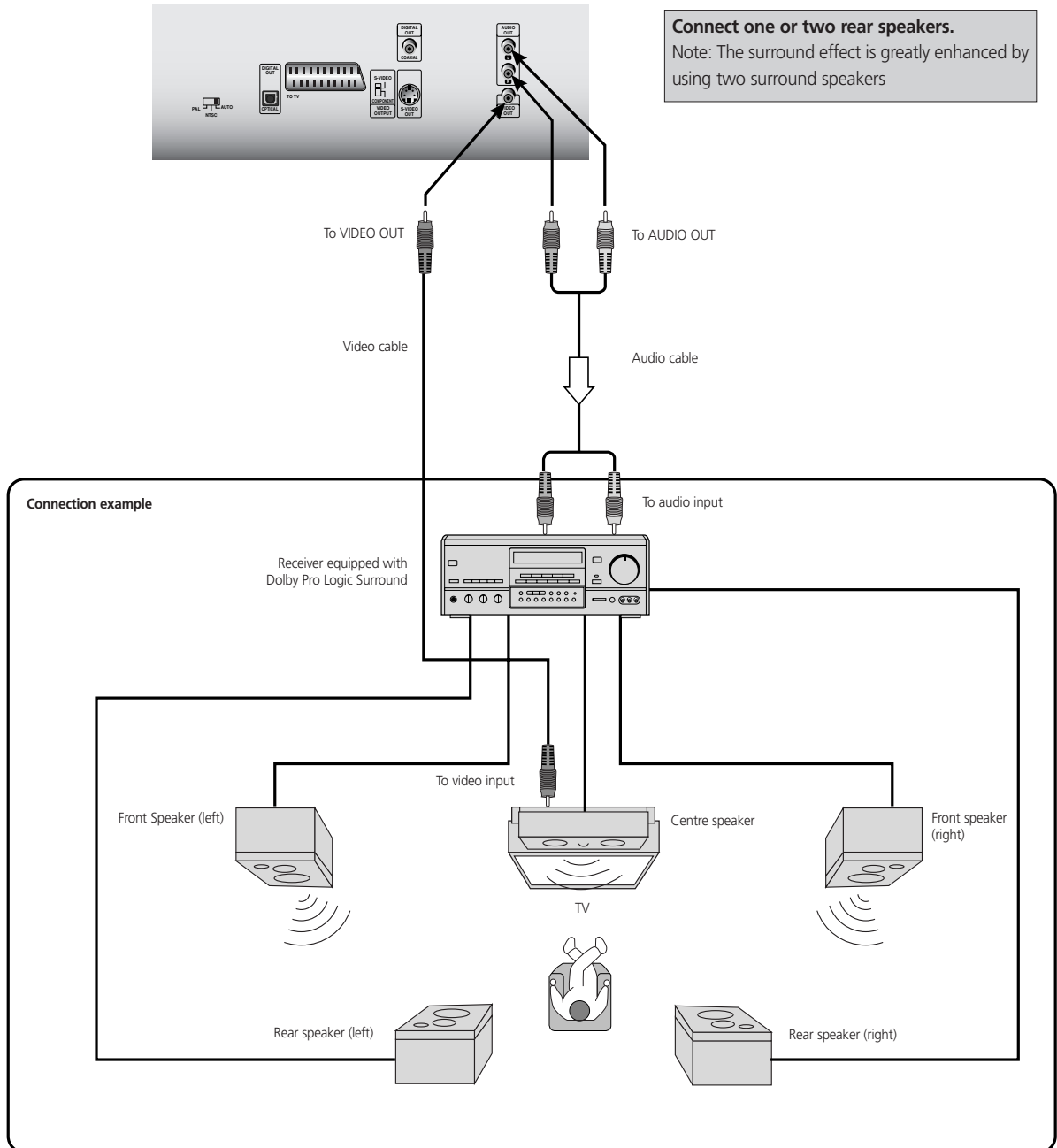

WITH A RECEIVER EQUIPPED WITH DOLBY DIGITAL

Connect the equipment the same way as described in Enjoying Dolby Digital Sound on page 9. Refer to that receiver's owner's manual and set the receiver so you can enjoy Dolby Pro Logic Surround sound.

WARNING

Do not set the Digital Audio Output of this DVD player to Dolby Digital unless you are connecting the DIGITAL OUT jack of this DVD player to an AV decoder that has the Dolby Digital decoding function. High volume sound may damage your hearing as well as the speakers (Refer to Selecting Digital Audio Output on page 20).

CONNECTING TO THE SURROUND SOUND SYSTEM

ENJOYING 2 CHANNEL DIGITAL STEREO SOUND

You can enjoy the dynamic sound of 2 Channel Digital Stereo by connecting this DVD player to a receiver equipped with a digital audio input and speaker system (right and left front speakers).

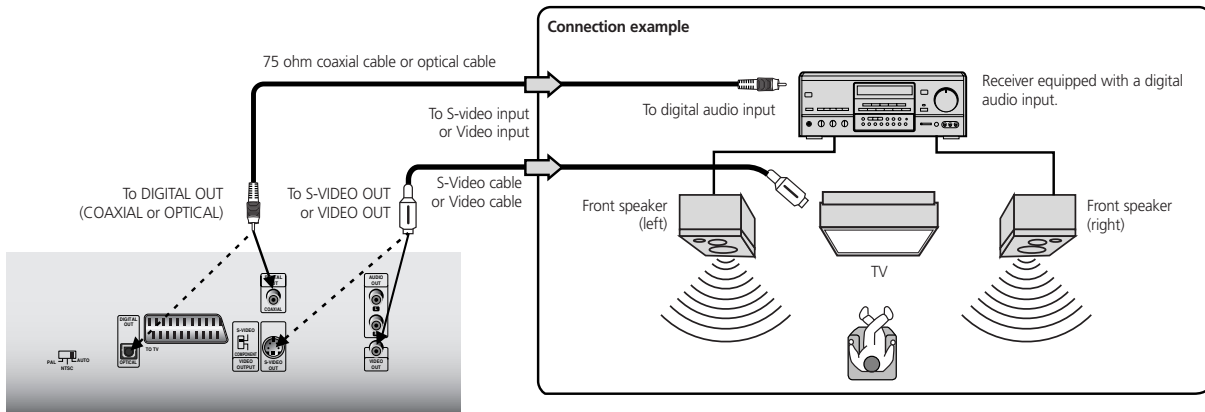

ENJOYING DTS SOUND

Your AV Receiver or processor must be equipped with a DTS Decoder
 The digital output (see selecting digital output page 20) must be set to "stream".
 The disc must have a DTS soundtrack

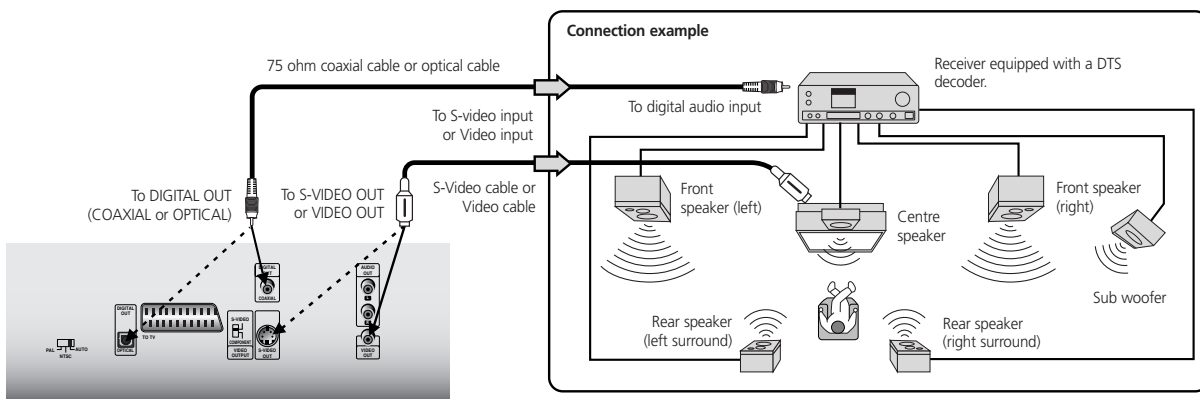

NOTES

- Refer to the owner's manual of your receiver as well.
- Before you connect the DVD player to other equipment, be sure to turn off the power and unplug all of the equipment from the wall outlet before making any connections.
- The output sound of the DVD player has a wide dynamic range. Be sure to adjust the receiver's volume to a moderate listening level. Otherwise, the speakers may be damaged by a sudden high volume sound.
- Turn off the receiver before you connect or disconnect the DVD player's power cord. If you leave the receiver power on, the speakers may be damaged.



Connections

CONNECTING TO A STEREO SYSTEM

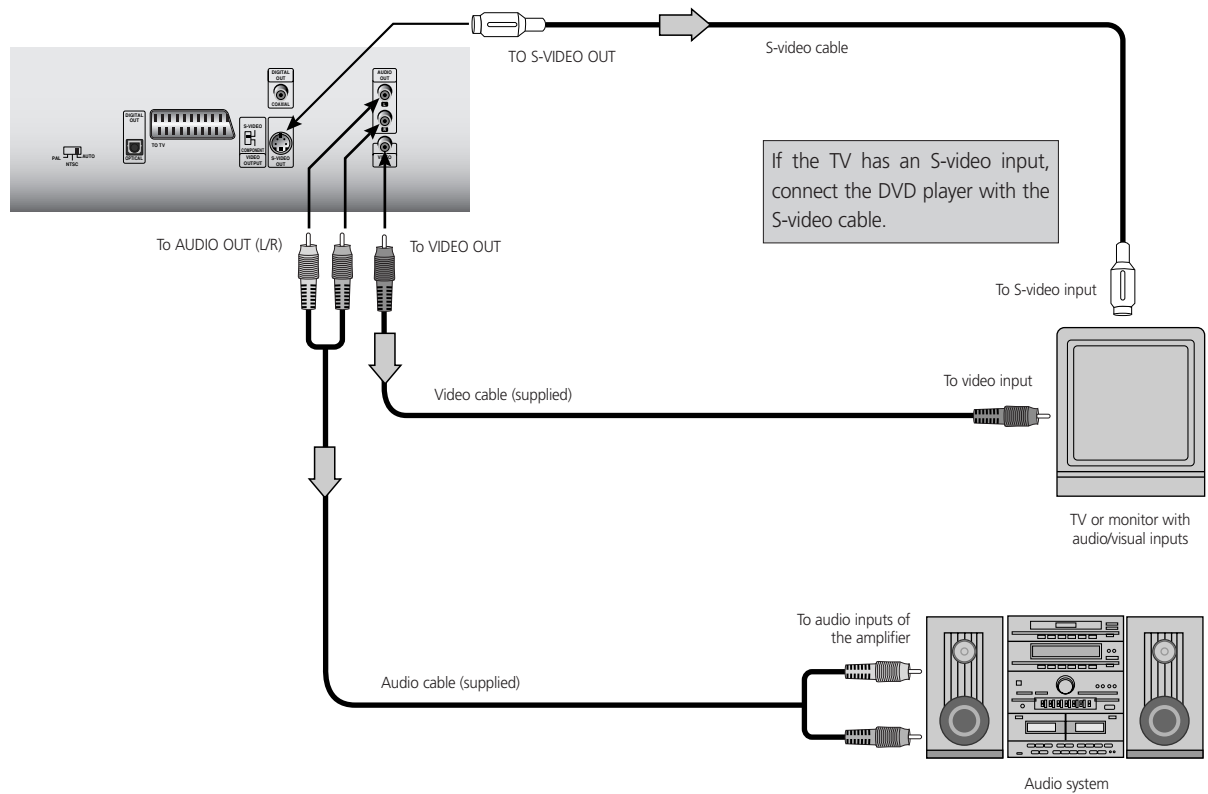

NOTES

- Refer to the owner's manual of your audio system as well.
- Before you connect the DVD player to other equipment, be sure to turn off the power and unplug all of the equipment from the wall outlet before making any connections.
- If you place the DVD player near a tuner or radio, the radio broadcast sound might be distorted. In this case, move the DVD player away from the tuner and radio.
- The output sound of the DVD player has a wide dynamic range. Be sure to adjust the receiver's volume to a moderate listening level. Otherwise, the speakers may be damaged by a sudden high volume sound.
- Turn off the receiver before you connect or disconnect the DVD player's power cord. If you leave the receiver power on, the speakers may be damaged.

WARNING

Do not set the Digital Audio Output of this DVD player to Dolby Digital unless you are connecting the DIGITAL OUT jack of this DVD player to an AV decoder that has the Dolby Digital decoding function. High volume sound may damage your hearing as well as the speakers (Refer to Selecting Digital Audio Output on page 20).

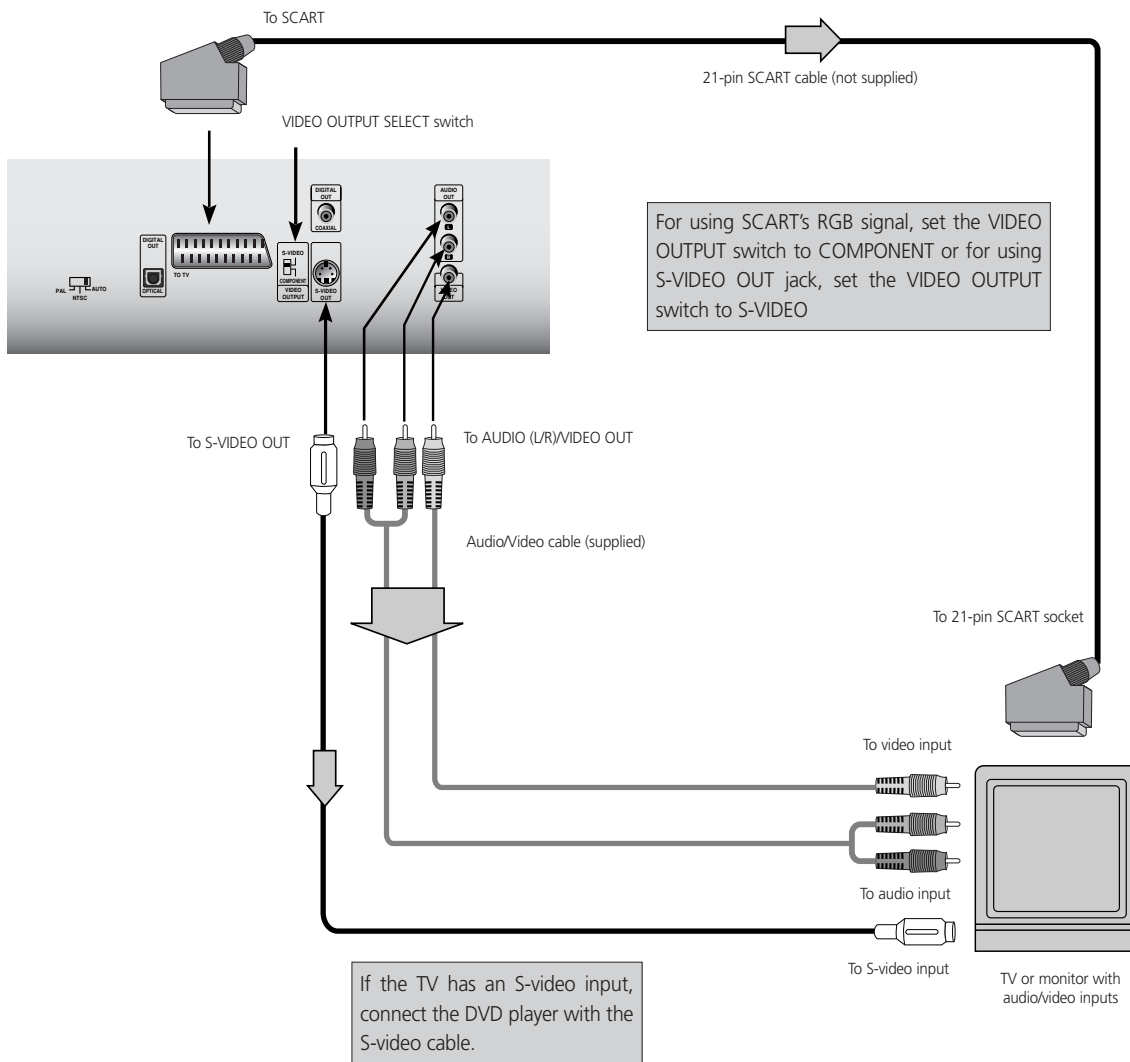

NOTES

- Refer to the owner's manual of your TV as well.
- Before you connect the DVD player to your TV, be sure to turn off the power and unplug both units from the wall outlet before making any connections.
- Connect the DVD player to your TV directly. If you connect the DVD player to a VCR, the playback picture will be distorted because DVD video discs are copy protected.
- In case of the TV set corresponding to RGB signal, the RGB signal is automatically selected in the TV (Only when the VIDEO OUTPUT Switch is set to COMPONENT on the Rear Panel).

WARNING

Do not set the Digital Audio Output of this DVD player to Dolby Digital unless you are connecting the DIGITAL OUT jack of this DVD player to an AV decoder that has the Dolby Digital decoding function. High volume sound may damage your hearing as well as the speakers (Refer to Selecting Digital Audio Output on page 20).

Initial Settings

SELECTION OF INITIAL SETTINGS

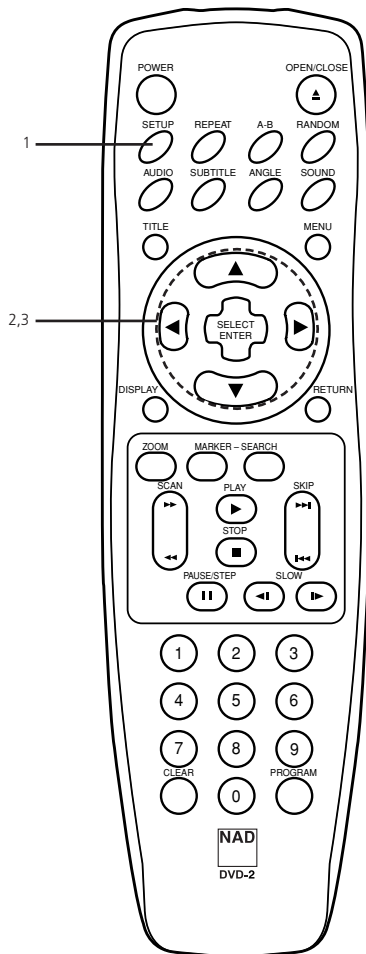

Once the initial settings have been completed, the player can always be operated under the same conditions (especially with DVD discs). The settings will be retained in the memory until they are changed, even if the power is switched off.

SELECTION OF INITIAL SETTINGS

1 Press SETUP in the stop or playback mode. The SETUP menu is displayed.



2 Press ▲/▼ to select the desired item. The screen will show the current setting for the selected item, and the alternate setting(s).

- Disc Audio (see page 15.)
- Disc Subtitle (see page 15.)
- Disc Menu (see page 15.)
- Rating (see page 16.)
- Country Code (see page 17.)
- TV Aspect (see page 18.)
- Menu Language (see page 19.)
- Digital Audio Output (see page 20.)
- Others (see page 21.)

3 Press ► and then ▲/▼ to select the desired setting and press SELECT/ENTER. Some items require additional steps. (See the respective page.)

When the alternate setting is selected the screen returns to the Initial Settings display.

To exit SETUP menu

Press SETUP, RETURN or PLAY.

This is to select the audio soundtrack language, subtitle language and the language used in title menus or DVD menu which will always be used for every disc to be played back.

When you play back a DVD video disc, the DVD player automatically displays the pre-selected subtitle language if it is included on the disc.

1 At the setup screen, press ▲/▼ to select “Disc Audio” and press ►



2 Press ▲/▼ to select the desired language and then press SELECT/ENTER



Original : The original language of each disc will be selected.

English : The English will be Selected.

Other : Another language can be selected. You can input 4-digit language code. (Refer to the language codes on page 22. Press CLEAR if an incorrect language code is entered.)

The Disc Subtitle and Disc Menu are selected by the same method.

When you play back a DVD videodisc, the DVD player automatically displays the pre-selected subtitle language if it is included on the disc.

NOTE

- If the language selected is not available on the disc, the original language designated by each disc will be selected.

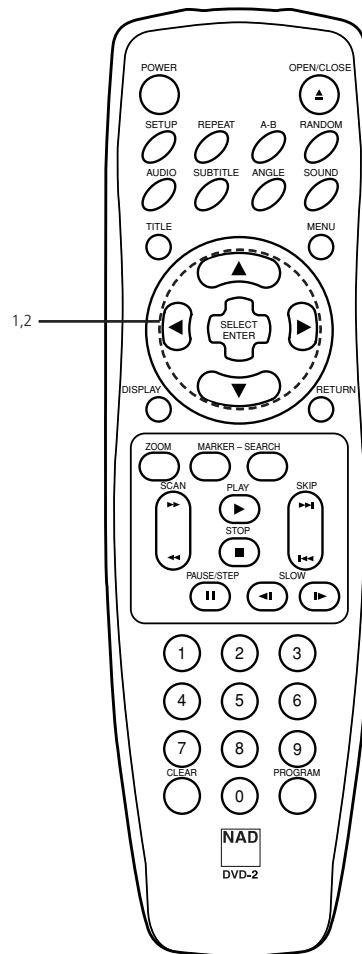

Initial Settings

SELECTING RATING LEVEL AND PASSWORD

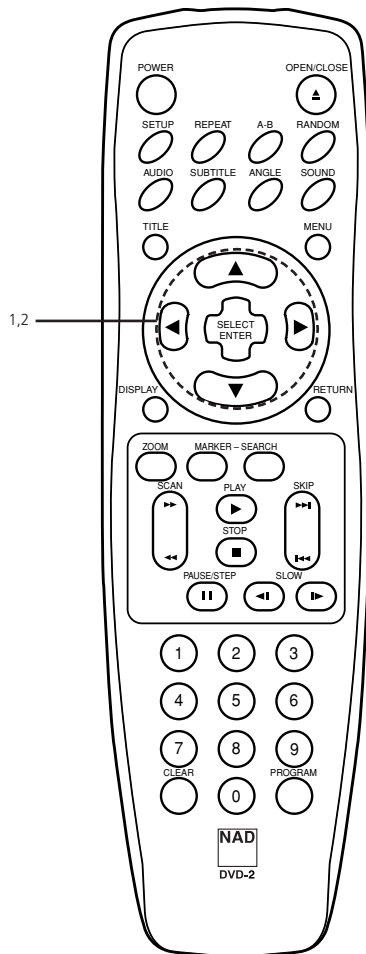

This is to prohibit the playing of specified DVDs which are unsuitable for children.

- Some DVD discs contain a restriction level which enables parents to remove scenes or prevent playback of discs by children. DVD players are equipped with a password designed to prevent children from changing the level.

SELECTING RATING LEVEL (DVD ONLY)

- At the **SETUP** screen, press **▲/▼** to select **"Rating"** and press **▶**. To add a password for the first time, you will be prompted to enter a "New" 4-digit password, press **SELECT/ENTER**, and then "Verify" the same 4-digit password and press **SELECT/ENTER**.

Example: 1234

Do not forget your password.

Disc Audio	8
Disc Subtitle	7
Disc Menu	6
Rating	5
Country Code	4
TV Aspect	3
Menu Language	2
	1
Digital Audio Output	▶Unlock Change
Others Change	

- Press **▲/▼** to select the desired level and press **SELECT/ENTER**

Disc Audio	8 Blocked
Disc Subtitle	7 Blocked
Disc Menu	✓6
Rating	5
Contry Code	4
TV Aspect	3
Menu Language	2
Progressive Scan	1
Digital Audio Output	Unlock Change
Others	

You cannot play DVD video discs rated higher than the level you selected unless you cancel the parental lock function.

For example, when you select level 7, discs rated higher than level 7 are blocked and cannot be played.

The parent lock level is equivalent to the following USA movie ratings.

Level 7: NC-17 Level 6: R Level 4: PG 13
Level 3: PG Level 1: G

Some titles do not match with the rating level described as above.

If you change the level and enter a password, playback of all DVDs with ratings higher than your selection will be blocked, unless the correct password is entered again. For example: if you change the level to 5, the DVD player will not play discs with ratings of 6, 7 or 8 unless the correct password is entered on the remote control.



TO CHANGE/CLEAR MEMORIZED PASSWORD

- 1 At the SETUP screen, press ▲/▼ to select "Password" and press ►
- 2 Input your password and press SELECT/ENTER
- 3 To change or clear your password, press ▲/▼ to select "Change" and press SELECT/ENTER. To change the rating level/password, follow the preceding steps.

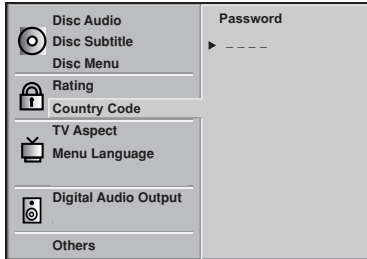

TO CLEAR YOUR 4-DIGIT PASSWORD

If you forget your password, to clear the current password, follow the procedure below.

At the SETUP screen

- Enter 6-digit number "210499" and then press SELECT/ENTER
- The 4-digit password is cleared. "P CLr" will show up in the DVD's florescent display as your confirmation.

SELECTING COUNTRY CODE (T532 ONLY) (DVD ONLY)

- 1 At the SETUP screen, press ▲/▼ to select "Country Code" and press ►
- 2 Enter your password then a cursor will be shown under the letters to be changed.
- 3 Press ◀ and ▶ to toggle through the letters for your geographical area

NOTE

Refer to the Country Code table found on page 22 for the appropriate code

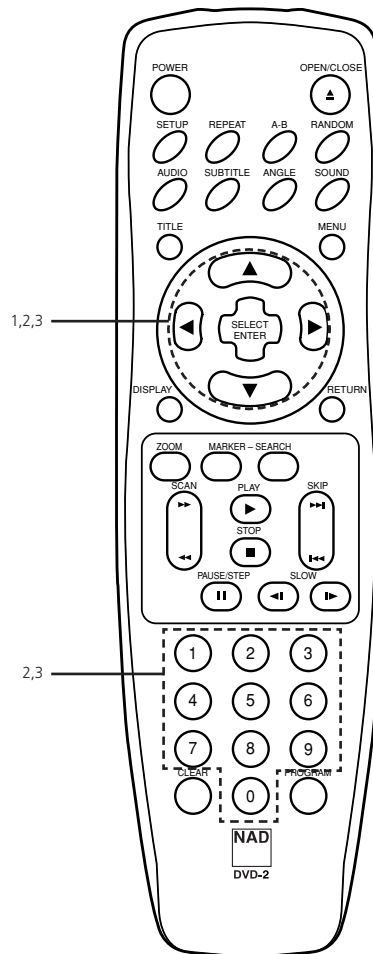

Initial Settings

SELECTING TV ASPECT

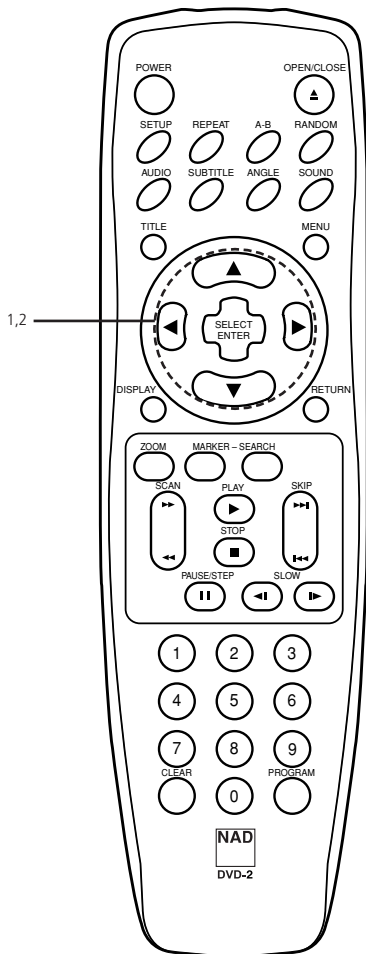

Select the appropriate screen type according to your TV set; conventional size screen (4:3) or wide-screen (16:9).

1 At the **SETUP** screen, press **▲/▼** to select **"TV Aspect"** and press **▶**

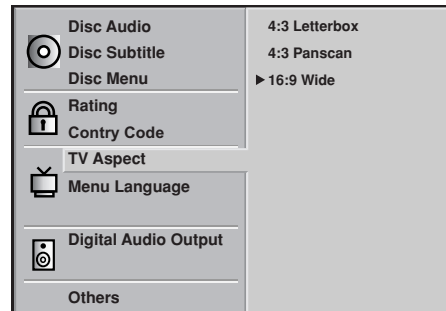

2 Press **▲/▼** to select the desired **Aspect** and press **SELECT/ENTER**

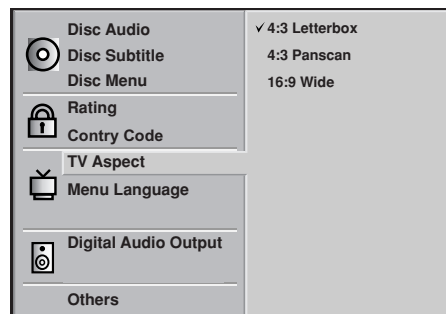

4 3 Letterbox : The video material not formatted in the Pan & Scan style is played back in the letterbox style (black bands appear at top and bottom of screen).

4 3 Panscan : Select when a conventional TV set is connected. The video material formatted in the Pan & Scan style is played back in that style (the left and right edges are cut off).

16 9 Wide : Select when a wide-screen TV set is connected. Played in **FULL** size. (Setting the wide-screen TV to **FULL** mode is also necessary.)



4:3 Letterbox

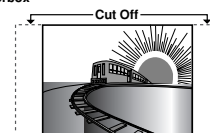

4:3 Panscan



16:9 Wide

- Each screen shows an example when the video material for a wide-screen is played. (This setting does not affect the video material for conventional size.).

Selects language for SETUP menus and displays on the TV.

- 1 At the SETUP screen, press ▲/▼ to select "Menu Language" and press ►



- 2 Press ▲/▼ to select the desired Language and SELECT/ENTER

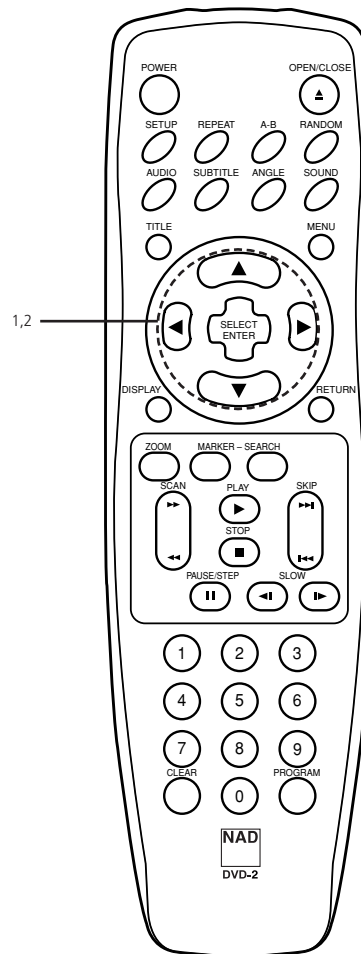

Initial Settings

SELECTING DIGITAL AUDIO OUTPUT

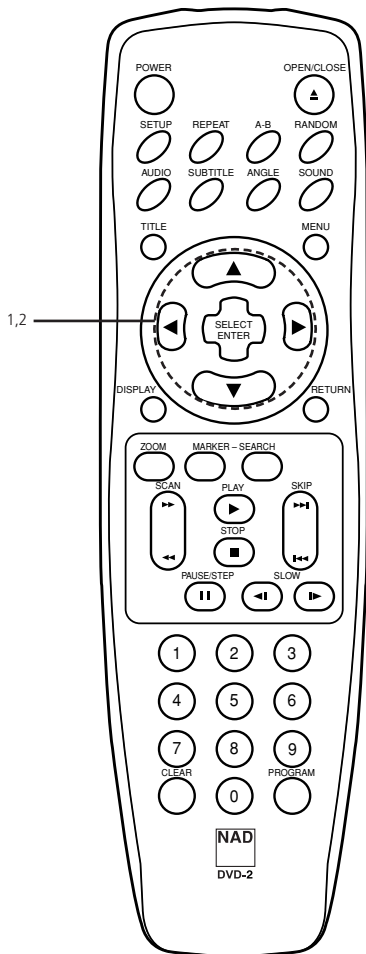

Each DVD disc has a variety of audio output options. Set the player's Digital Audio Output according to the type of audio system you use.

- At the **SETUP** screen, press **▲/▼** to select **Digital Audio Output** and press **▶**

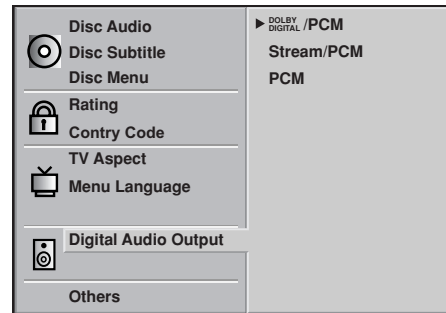

- Press **▲/▼** to select the desired output and press **SELECT/ENTER**

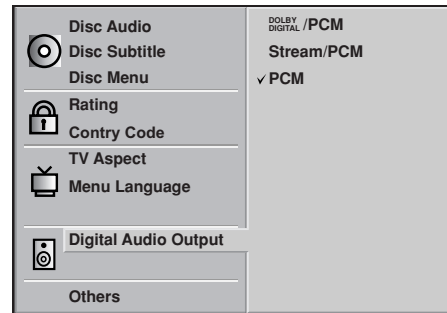

DOLBY DIGITAL/PCM : Select DOLBY DIGITAL/PCM if an active digital output is supplied to a Dolby Digital decoder, (or an amplifier or other equipment with Dolby Digital decoder). In this mode, the T531 will automatically switch between Dolby Digital and Stereo PCM depending on the program encoded on the disc, with Dolby Digital given priority. DTS is not possible with this setting.

Stream/PCM : Select Stream/PCM if an active digital output is supplied to an amplifier or other equipment with DTS decoder, Dolby Digital decoder and MPEG decoder.

PCM : Select PCM if an active digital output is supplied to an amplifier or other equipment with linear PCM only (or MD recorder or DAT deck). 5.1 Surround Sound modes are not possible with this setting.

NOTES

- When you are not using the player's digital audio output, don't select any of the options.
- If an active digital audio output signal is supplied to a receiver or other equipment without a corresponding digital decoding capability, a very loud noise may be produced which could permanently damage the speakers.
- The DTS DVD disc sound is played back only when the DVD player is connected to a receiver with a DTS decoder.

Playback Disc	OUTPUT		
	Stream/PCM	Dolby Digital/PCM	PCM only
48 & 96 kHz Linear PCM DVD	PCM	PCM	PCM
DTS DVD	DTS bit Stream	Not Output	Not Output
Dolby Digital DVD	Dolby Digital bit Stream	Dolby Digital bit Stream	PCM
MPEG DVD	MPEG bit Stream	PCM	PCM
Audio CD	PCM	PCM	PCM
DTS Audio CD	DTS bit Stream	DTS bit Stream	DTS bit Stream

The DRC and PBC settings can be changed.

- 1 At the SETUP screen, press ▲/▼ to select "Others" and press ►

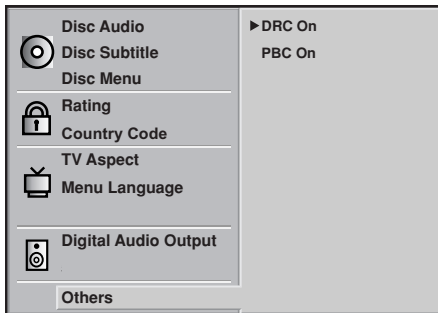

- 2 Press ▲/▼ to select the desired items and press SELECT/ENTER. The setting of the selected items are changed between On and Off.

DRC (DYNAMIC RANGE COMPRESSION) ON/OFF

On : Select this option to turn on the Dynamic Range Compression circuitry so that the dialogue remains clear even at low volume levels.

Off : Select this option to turn off the Dynamic Range Compression and have the soundtrack presented exactly as it was created.

PBC ON/OFF

Set Playback Control (PBC) to On or Off

On : Video CDs with PBC are played back according to the PBC.

Off : Video CDs with PBC are played back in the same way Audio CDs.

NOTE

PBC is only available for the T532

ABOUT DRC (DYNAMIC RANGE COMPRESSION)

With the DVD format you have the opportunity to hear a programs soundtrack in the most accurate and realistic presentation possible, thanks to the use of digital audio technology. However, in certain instances you may wish to slightly compress the dynamic range of the audio output (the difference between the loudest sounds and the quietest ones) so that you may listen to a movie at a lower volume without losing dialogue intelligibility.

NOTES

- The DRC function works only during playback of Dolby Digital recorded discs.
- The level of Dynamic Range Compression may differ depending on the DVD disc.
- When playing karaoke, connect appropriate audio equipment (such as an amplifier) to the DVD video player.

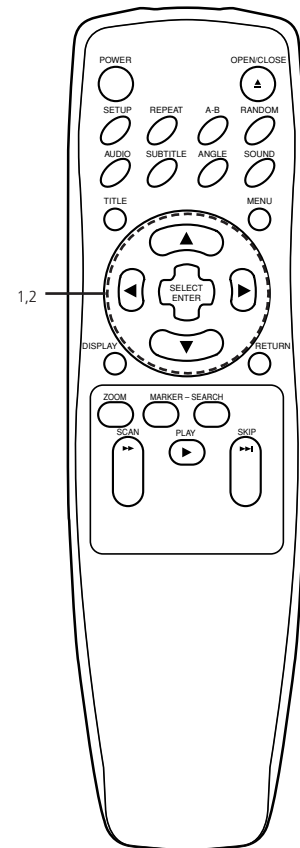

Initial Settings

TABLE OF LANGUAGES AND THEIR CODES



Enter the appropriate code number for the initial settings "Audio", "Subtitle" and/or "Menu" (see page 15)

Code	Language	Code	Language	Code	Language	Code	Language
6565	Afar	7079	Faroese	7678	Lingala	8375	Slovak
6566	Abkhazian	7082	French	7679	Laothian	8376	Slovenian
6570	Afrikaans	7089	Frisian	7684	Lithuanian	8377	Samoa
6577	Ameharic	7165	Irish	7686	Latvian, Lettish	8378	Shona
6582	Arabic	7168	Scots Gaelic	7771	Malagasy	8379	Somali
6583	Assamese	7176	Galician	7773	Maori	8381	Albanian
6588	Aymara	7178	Guarani	7775	Macedonian	8382	Serbian
6590	Azerbaijani	7185	Gujarati	7776	Malayalam	8385	Sudanese
6665	Bashkir	7265	Hausa	7778	Mongolian	8386	Swedish
6669	Byelorussian	7273	Hindi	7779	Moldavian	8387	Swahili
6671	Bulgarian	7282	Croatian	7782	Marathi	8465	Tamil
6672	Bihari	7285	Hungarian	7783	Malay	8469	Telugu
6678	Bengali; Bangla	7289	Armenian	7784	Maltese	8471	Tajik
6679	Tibetan	7365	Interlingua	7789	Burmese	8472	Thai
6682	Breton	7378	Indonesian	7865	Nauru	8473	Tigrinya
6765	Catalan	7383	Icelandic	7869	Nepali	8475	Turkmen
6779	Corsican	7384	Italian	7876	Dutch	8476	Tagalog
6783	Czech	7387	Hebrew	7879	Norwegian	8479	Tonga
6789	Welsh	7465	Japanese	7982	Oriya	8482	Turkish
6865	Danish	7473	Yiddish	8065	Panjabi	8484	Tatar
6869	German	7487	Javanese	8076	Polish	8487	Twi
6890	Bhutani	7565	Georgian	8083	Pashto, Pushto	8575	Ukrainian
6976	Greek	7575	Kazakh	8084	Portuguese	8582	Urdu
6978	English	7576	Greenlandic	8185	Quechua	8590	Uzbek
6979	Esperanto	7577	Cambodian	8277	Rhaeto-Romance	8673	Vietnamese
6983	Spanish	7578	Kannada	8279	Rumanian	8679	Volapük
6984	Estonian	7579	Korean	8285	Russian	8779	Wolof
6985	Basque	7583	Kashmiri	8365	Sanskrit	8872	Xhosa
7065	Persian	7585	Kurdish	8368	Sindhi	8979	Yoruba
7073	Finnish	7589	Kirghiz	8372	Serbo-Croatian	9072	Chinese
7074	Fiji	7665	Latin	8373	Singhalese	9085	Zulu

TABLE OF COUNTRY CODES



AD	Andorra	CV	Cape Verde	IE	Ireland	MU	Mauritius	SN	Senegal
AE	United Arab Emirates	CX	Christmas Island	IL	Israel	MV	Maldives	SO	Somalia
AF	Afghanistan	CY	Cyprus	IN	India	MW	Malawi	SR	Suriname
AG	Antigua and Barbuda	CZ	Czech Republic	IO	British Indian Ocean Territory	MX	Mexico	ST	Saint Tome
AI	Anguilla	DE	Germany	IQ	raq	MY	Malaysia	SU	Former USSR
AL	Albania	DJ	Djibouti	IR	Iran	MZ	Mozambique	SV	El Salvador
AM	Armenia	DK	Denmark	IS	Iceland	NA	Namibia	SY	Syria
AN	Netherlands Antilles	DM	Dominica	IT	Italy	NC	New Caledonia (French)	SZ	Swaziland
AO	Angola	DO	Dominican Republic	JM	Jamaica	NE	Niger	TC	Turks and Caicos
AQ	Antarctica	DZ	Algeria	JO	Jordan	NF	Norfolk Island	TD	Chad
AR	Argentina	EC	Ecuador	JP	Japan	NG	Nigeria	TG	French Southern Territories
AS	American Samoa	EG	Egypt	KE	Kenya	NI	Nicaragua	TF	Togo
AT	Austria	EH	Western Sahara	KG	Kyrgyzstan	NL	Netherlands	TH	Thailand
AU	Australia	ER	Eritrea	KH	Cambodia	NO	Norway	TJ	Tadjikistan
AW	Aruba	ES	Spain	KI	Kiribati	NP	Nepal	TK	Tokelau
AZ	Azerbaijan	ET	Ethiopia	KM	Comoros	NR	Nauru	TM	Turkmenistan
BA	Bosnia-Herzegovina	FI	Finland	KN	Saint Kitts & Nevis Anguilla	NU	Niue	TN	Tunisia
BB	Barbados	FJ	Fiji	KP	North Korea	NZ	New Zealand	TO	Tonga
BD	Bangladesh	FK	Falkland Islands	KR	South Korea	OM	Oman	TP	East Timor
BE	Belgium	FM	Micronesia	KW	Kuwait	PA	Panama	TR	Turkey
BF	Burkina Faso	FO	Faroe Islands	KY	Cayman Islands	PE	Peru	TT	Trinidad and Tobago
BG	Bulgaria	FR	France	KZ	Kazakhstan	PF	Polynesia (French)	TV	Tuvalu
BH	Bahrain	FX	France (European Territory)	LA	Laos	PG	Papua New Guinea	TW	Taiwan
BI	Burundi	GA	Gabon	LB	Lebanon	PH	Philippines	TZ	Tanzania
BJ	Benin	GB	Great Britain	LC	Saint Lucia	PK	Pakistan	UA	Ukraine
BM	Bermuda	GD	Grenada	LI	Liechtenstein	PL	Poland	UG	Uganda
BN	Brunei Darussalam	GE	Georgia	LK	Sri Lanka	PM	Saint Pierre and Miquelon	UK	United Kingdom
BO	Bolivia	GF	French Guyana	LR	Liberia	PN	Pitcairn Island	UM	USA Minor Outlying Islands
BR	Brazil	GH	Ghana	LS	Lesotho	PR	Puerto Rico	US	United States
BS	Bahamas	GI	Gibraltar	LT	Lithuania	PT	Portugal	UY	Uruguay
BT	Bhutan	GL	Greenland	LU	Luxembourg	PW	Palau	UZ	Uzbekistan
BV	Bouvet Island	GM	Gambia	LV	Latvia	PY	Paraguay	VA	Vatican City State
BW	Botswana	GN	Guinea	LY	Libya	QA	Qatar	VC	Saint Vincent & Grenadines
BY	Belarus	GP	Guadeloupe (French)	MA	Morocco	RE	Reunion (French)	VE	Venezuela
BZ	Belize	GQ	Equatorial Guinea	MC	Monaco	RO	Romania	VG	Virgin Islands
CA	Canada	GR	Greece	MD	Moldavia	RU	Russian Federation	VI	Virgin Islands
CC	Cocos (Keeling) Islands	GS	Georgia & S. Sandwich Isls.	MG	Madagascar	RW	Rwanda	VN	Vietnam
CF	Central African Republic	GT	Guatemala	MH	Marshall Islands	SA	Saudi Arabia	VU	Vanuatu
CG	Congo	GU	Guam (USA)	MK	Macedonia	SB	Solomon Islands	WF	Wallis and Futuna
CH	Switzerland	GW	Guinea Bissau	ML	Mali	SC	Seychelles	WS	Samoa
CI	Ivory Coast	GY	Guyana	MM	Myanmar	SD	Sudan	YE	Yemen
CK	Cook Islands	HK	Hong Kong	MN	Mongolia	SE	Sweden	YT	Mayotte
CL	Chile	HM	Heard and McDonald Isls.	MO	Macau	SG	Singapore	YU	Yugoslavia
CM	Cameroon	HN	Honduras	MP	Northern Mariana Islands	SH	Saint Helena	ZA	South Africa
CN	China	HR	Croatia	MQ	Martinique (French)	SI	Slovenia	ZM	Zambia
CO	Colombia	HT	Haiti	MR	Mauritania	SJ	Svalbard and Jan Islands	ZR	Zaire
CR	Costa Rica	HU	Hungary	MS	Montserrat	SK	Slovak Republic	ZW	Zimbabwe
CS	Former Czechoslovakia	ID	Indonesia	MT	Malta	SL	Sierra Leone		
CU	Cuba					SM	San Marino		

This section shows you the basics on how to play back a DVD video disc

PREPARATIONS

- When you want to play back DVD video discs, turn on the TV and select the video input source connected to the DVD player.
- When you want to enjoy the sound of DVD video discs or audio CDs from the audio system, turn on the audio system and select the input source connected to the DVD player.
- For connection details, see pages 9-11.
- Set the playback picture size according to the aspect ratio of the connected TV at the SETUP menu (TV Aspect).
- If you do not have the necessary equipment to enjoy Dolby Digital sound, set the Digital Audio Output at the SETUP menu to PCM .

1 Press POWER. The DVD player turns on and the power indicator lights.

2 Press OPEN/CLOSE. The disc tray opens.

- You can open the disc tray by pressing this button even if the DVD player is in standby mode.

3 Place a disc on the disc tray with the playback side down.

- There are two different disc sizes. Place the disc in the correct guide on the disc tray. If the disc is out of the guide, it may damage the disc and cause the DVD player to malfunction.
- Do not place anything except 3 discs or 5 discs on the disc tray.

4 Press PLAY. The disc tray is automatically closed and playback begins.

- If the disc is placed in upside down (and it is a single sided disc), NO DISC or DISC ERROR appears on the TV screen.



Operating Status indicator

- If you insert an audio CD, the CD indicator lights up in the DVD display. The title number does not appear.
- After playing back all of the chapters in the title, the DVD player automatically stops and returns to the menu screen.

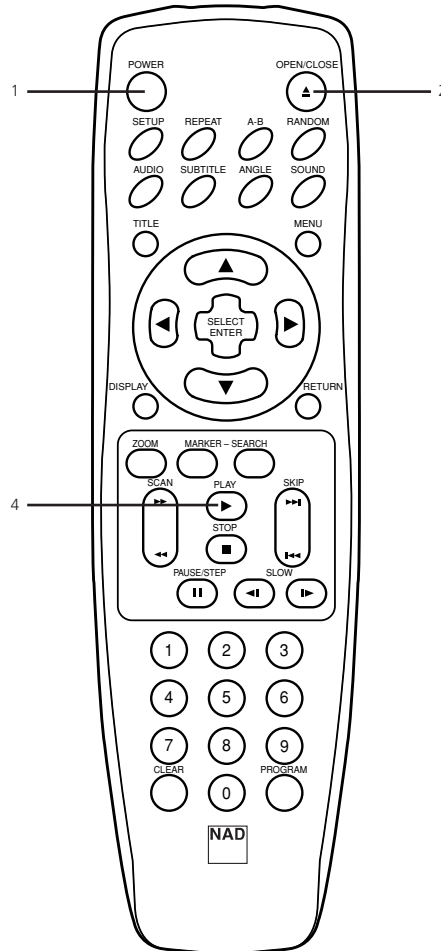
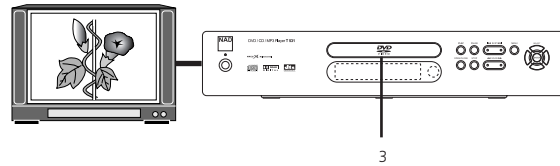

WHEN A MENU SCREEN APPEARS ON THE TV SCREEN

In case of interactive DVDs with control, a menu screen appears on the TV screen. Perform step 5 on page 24 to start play.

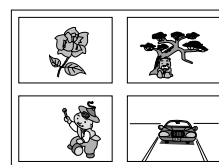

Example of interactive DVD on-screen menu



Basic Operations

BASIC PLAYBACK

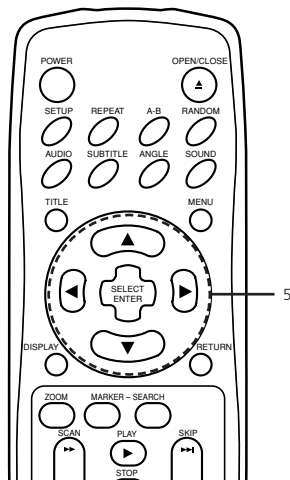

5 Press ▲/▼/◀/▶ and press SELECT/ENTER, or press the numeric button(s), to select the desired item.

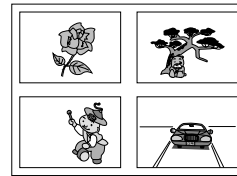
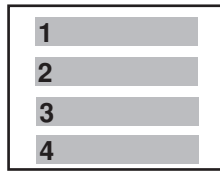

Play of the selected item now begins.

- For further information, also refer to the jacket or case of the disc you are playing.

AFTER OPERATION

When the unit is not in use, remove the disc and press POWER to turn off the power.

NOTES

- Do not move the DVD player during playback. Doing so may damage the disc and the DVD player.
- Use the OPEN/CLOSE button on the remote control or DVD player to open and close the disc tray. Do not push the disc tray while it is moving. Doing so may cause the DVD player to malfunction.
- Do not push up the disc tray or put any objects other than discs on the disc tray. Doing so may cause the DVD video player to malfunction.
- Keep your fingers well clear of the disc tray as it is closing. Be especially careful with children's fingers around the closing disc tray as there is a risk of personal injury.
- When  appears on the TV screen while a button is pressed, it means that this function is not available on the disc you are playing.
- Depending on the DVD disc, some operations may be different or restricted. Refer to the jacket or case of the disc you are playing.

SCREEN SAVER

The screen saver is useful to prevent your display from becoming damaged. The screen saver picture appears when you leave the DVD player in stop mode for about 5 minutes.

AUTOMATIC POWER OFF FUNCTION

After the Screen Saver has been engaged for about 5 minutes, the DVD player will automatically turn itself off.

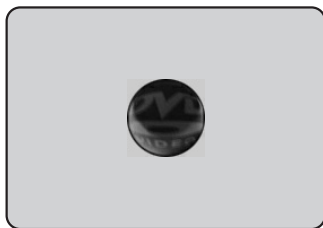

Screen Saver



STOPPING PLAY

Press STOP during playback

RESUME PLAY

When play is stopped, the unit records the point where STOP was pressed (RESUME function).

Press PLAY and play will resume from this point.

NOTES

- Resume function will be cleared when the STOP is pressed on the STOP mode.
- Resume function will be cleared when the power is turned off and then on.
- Opening the disc tray cancels Resume function.
- The Resume function may not be available on some DVD discs.

STILL PICTURE (PAUSE)

Press PAUSE/STEP during playback

DVD The player will be placed in the still picture mode.

CD The player will be placed in the pause mode.

FRAME ADVANCE (DVD ONLY)

Press PAUSE/STEP during still playback. (Each time you press PAUSE/STEP, the picture advances one frame)

To resume normal playback, press PLAY

SKIPPING CHAPTERS AND TRACKS

Skipping forward

Press SKIP ►►► during playback

A chapter (DVD) or a track (CD) is skipped each time the button is pressed.

Skipping back

Press SKIP ◀◀◀ during playback

When the button is pressed once midway through a chapter/track, the player returns to the start of that chapter/track. When it is pressed again, a chapter/track is skipped each time the button is pressed.

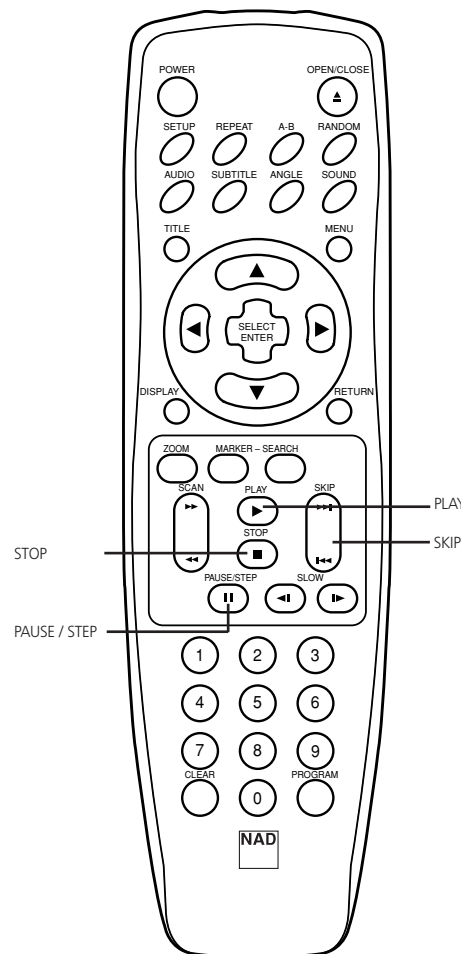

Basic Operations

BASIC PLAYBACK

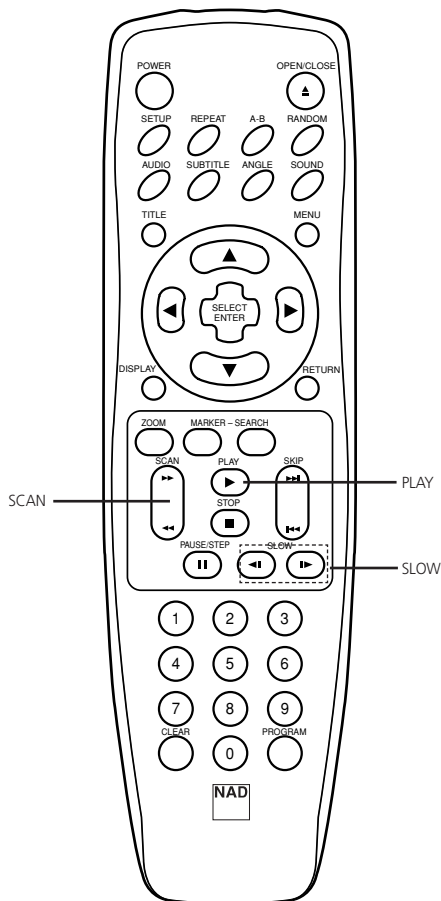

You can play back discs at various speeds.

TO SCAN AT FAST FORWARD OR FAST REVERSE PLAYBACK

Press the SCAN ◀◀ or ▶▶ button during playback

[TV screen]



- The speed of advance (reverse) is relatively slow at first. When the button is pressed again, the speed becomes faster. (Each time the button is pressed, the speed increases up to 4 steps (DVD) or 1 step (CD).)
- The speed will be retained even after the button is released.

To return to normal playback, press PLAY

NOTE

- The DVD player does not play back sound during the high speed reverse and forward playback of DVD video discs. However, the DVD player plays back sound during fast forward or fast reverse playback of audio CDs.

PLAYING IN SLOW-MOTION (DVD ONLY)

Press SLOW ◀◀ or ▶▶ during playback

The playback speed becomes 1/16 of the normal speed.

[TV screen]



- The speed of slow-motion is slow at first. When the button is pressed again, the speed becomes faster. Each time the button is pressed, the speed increase up to 4 steps.
- The speed will be retained even after the button is released.

To return to normal playback, press PLAY

NOTES

- The sound is muted during slow-motion playback.
- Subtitles do not appear on the screen during slow motion playback.
- The SLOW buttons do not work with Audio CDs.

Operation Using Menu Icons (Graphical User Interface)



GENERAL INFORMATION ABOUT GUI MENU ICONS

This unit features GUI Menu Icons showing disc information (title/chapter/track number, elapsed playing time, audio/subtitle language, angle, and sound) and player information (repeat play, play mode, marker, etc.). Some icons only show the indicated information. Other icons allow the settings to be changed.

COMMON PROCEDURES

1 Press DISPLAY during playback.

- Title function can be accessed from the stop mode.

2 Press ▲/▼ to select the desired item.

- The current selected item is indicated by a yellow frame on its GUI menu icons.

3 Press ◀/▶ to select the desired setting.

- When numbers are displayed (e.g. title number), the numeric buttons can also be used for setting instead of ◀/▶
- For some functions, the setting will be registered immediately; for others, SELECT/ENTER must be pressed.

To clear the GUI Menu Icons, press DISPLAY again

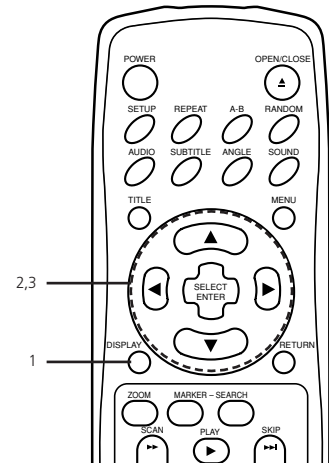

EXAMPLES OF GUI MENU ICONS

(The screens may differ depending on the disc contents.)

DVD GUI



CD GUI



DVD and CD GUI

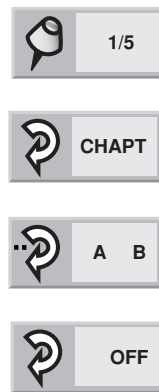







Operation Using Menu Icons (Graphical User Interface)





DETAILED DESCRIPTION OF EACH GUI MENU ICON



Press **DISPLAY** during playback
[TV screen] DVD GUI

	FUNCTION (Press ▲/▼ to select desired item)	SELECTION METHOD
 1	To show the current title number, and to jump to the desired title number.	◀/▶ or Numeric SELECT/ENTER
 1	To show the current chapter number and to jump to the desired chapter number.	◀/▶ or Numeric SELECT/ENTER SKIP
 0:16:57	To show the elapsed time and directly select scenes by the desired time.	Numeric SELECT/ENTER
 1 ENG D D 6 CH	To show the current audio soundtrack language, encoding method, channel number and to change the setting.	◀/▶ AUDIO
 OFF	To show the current subtitles language and to change the setting.	◀/▶ SUBTITLE
 1	To show the current angle number and to change the angle.	◀/▶ ANGLE
 NORM.	To show the current sound (NORMAL or 3D SURROUND) and to change the setting.	◀/▶

Press **DISPLAY** during playback
[TV screen] CD GUI

	FUNCTION (Press ▲/▼ to select desired item)	SELECTION METHOD
 1	To show the current track number and to jump to the desired track number.	◀/▶ or Numeric SELECT/ENTER SKIP
 16:57	To show the elapsed time. (Display only)	-
 STER.	To show the current audio (STEREO, LEFT, RIGHT) and to select to the desired audio channel.	◀/▶ AUDIO
 NORM.	To show the current sound (NORMAL or 3D SURROUND) and to change the setting.	◀/▶

NOTES

- Some DVD discs may not provide all of the above GUI menu icons.

Some movie discs may contain two or more titles. If the disc has a title menu recorded on it, the TITLE button can be used to select the movie title. (The details of operation differ depending on the disc used.)

- *Selecting a title may not be possible on certain DVD discs.*

1 Press TITLE.

A list of the titles on the disc is displayed.

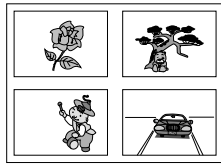

Pressing TITLE again to resume play from the scene when TITLE was first pressed.

2 Press ▲/▼/◀/▶ and press ENTER or PLAY, or press the numeric button(s), to select desired title.

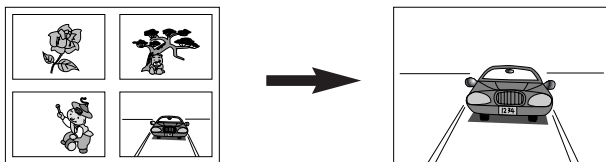

The selected title now starts playing.

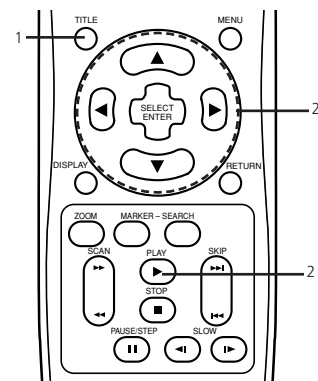

Some DVDs have unique menu structures called DVD menus. For example, DVDs programmed with complex contents provide guide menus, and those recorded with various languages provide menus for audio and subtitle language. Although the DVD menu's contents and operation differ from disc to disc, the following explains the basic operation when this feature is used.

1 Press MENU during play.

The DVD menu available on the disc is now displayed.

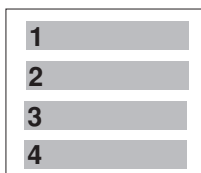

Pressing MENU again resumes play from the scene when MENU was first pressed.

- Resume play may not be possible on certain discs.

2 Press ▲/▼/◀/▶ and press ENTER, or press the numeric button(s), to select desired item.

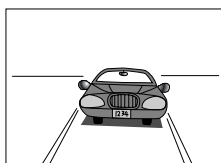

The selected item is now executed.

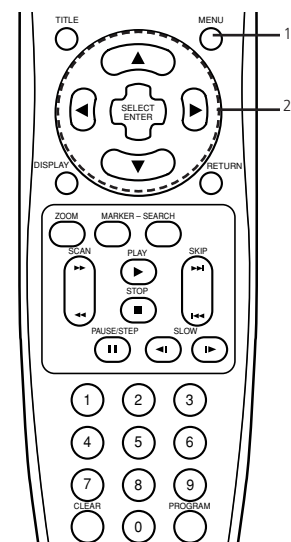

Advanced Operation

MEMORIZING SETTINGS FOR VIEWED DVDS (T532 ONLY)



This unit will memorize settings for the last DVD you watched. Settings remain in memory even if you remove the disc from the player, or switch power to the player OFF. Settings are stored in memory for use any time automatically.

NOTES

- Settings are stored in memory for use any time.
- This unit does not store settings in memory, if you remove the disc from the player or switch power to the player OFF when DVD or title menu is displayed on the TV screen.

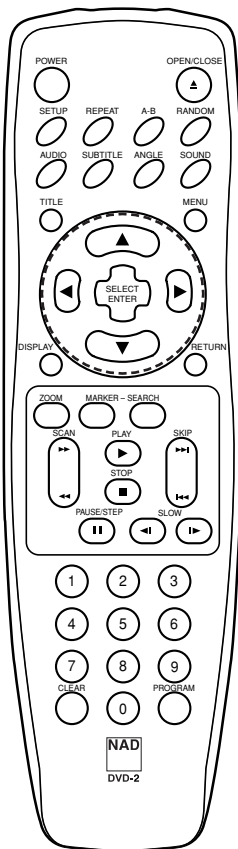

GB



It is possible to change the subtitle language to a different language from the one selected at the initial settings. (See page 15 for further info.)

This operation works only with discs on which multiple subtitle languages are recorded.

1 Press SUBTITLE during playback. When no subtitles are recorded, "OFF" will be displayed instead of the language number.



2 Press SUBTITLE repeatedly until the desired language is selected. Number of the subtitle language being played back is shown



To eliminate the On Screen Subtitles.

Press SUBTITLE repeatedly to select OFF at step 2.

NOTES

- In some cases, the subtitle language is not changed to the selected one immediately.
- When a disc supporting the closed caption is played, the subtitle and the closed caption may overlap each other on the TV screen. In this case, turn the subtitle off.
- When the desired language is not selected even after pressing the button several times, it means that the language is not available on the disc.
- When the power is turned on or the disc is removed, subtitles appears in the language selected at the initial settings. If this language is not recorded on the disc, the disc's priority language appears.

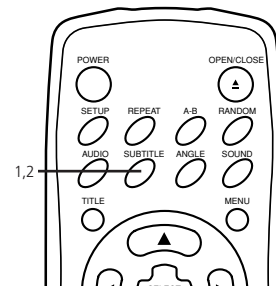

It is possible to change the audio soundtrack language to a different language from the one selected at the initial settings in case of DVD disc. (See page 15 for further info.) This operation works only with discs on which multiple audio soundtrack languages are recorded.

And it is possible to change the audio channel in case of audio CD.

DVD

1 Press AUDIO during play. Number of the audio soundtrack language being played back.



2 Press AUDIO repeatedly until the desired language (or encoding method, channel number) is selected.



CD

1 Press AUDIO during play.



2 Press AUDIO repeatedly until the desired sound is selected.



NOTES

- When the desired language is not selected even after pressing the button several times, it means that the language is not available on the disc.
- When the power is turned on or the disc is removed, the language heard is the one selected at the initial settings. If this language is not recorded on the disc, only the available language on the disc will be heard.
- Some discs may not respond to Audio feature.

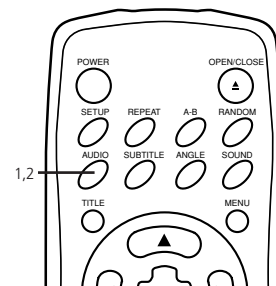

Advanced Operation

VIEWING FROM ANOTHER ANGLE

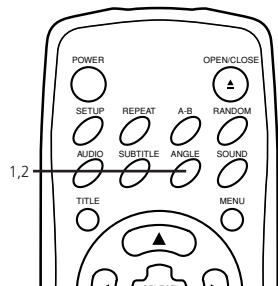

Some DVDs may contain scenes which have been shot simultaneously from a number of different angles. For these discs, the same scene can be viewed from each of these different angles using the ANGLE button. (The recorded angles differ depending on the disc used.)

1 Press ANGLE during playback. Number of angle being played back.



2 Press ANGLE repeatedly until the desired angle is selected.

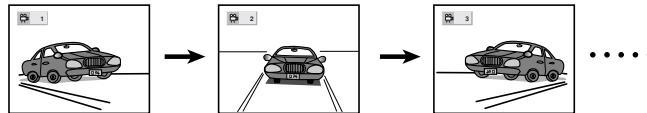

FOR YOUR REFERENCE

The ANGLE indicator will blink in the DVD display window at scenes recorded at different angles to indicate that angle switching is possible. The angle number can be programmed beforehand; the angle will be switched to the selected number when the ANGLE indicator blinks.

NOTE

- This function only works for discs having scenes recorded at different angles.

PRODUCING A 3D SURROUND EFFECT

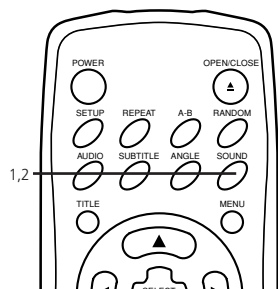

This unit can produce a 3D Surround effect, using Spatializer technology, which simulates multi-channel audio playback from two conventional stereo speakers instead of the five or more speakers normally required to listen to multi-channel audio from a home theatre. This feature works with DVD discs encoded with Dolby Pro Logic and Dolby Digital audio tracks.

1 Press SOUND during playback. Each time this button is pressed, the TV screen displays changes.



2 Press SOUND repeatedly until the desired sound is selected.



NOTE

- This 3D Surround effect may not be available on some DVD discs, such as those recorded with a mono audio sound-track.
- Turn off the TV surround sound and other surround effects when using this 3D surround effect.
- For best 3D Surround effect using only two speakers it is recommended that the two speakers be positioned approximately 2m to 2.5m apart, and the listening position should be 2m to 2.5m away from the speakers.

REPEATING VIEWING (LISTENING)

Press REPEAT during playback

Each time this button is pressed, the TV screen changes as shown below and the disc will repeat a chapter or title (DVD) or a track (CD).

DVD

Repeat of chapter being played

Repeat of title being played

Cancel repeat mode
(normal play)

CD

Repeat of track being played

Repeat of entire disc contents

Cancel repeat mode
(normal play)

To enjoy program repeat play (CD)

If REPEAT is pressed during program play, repeat play is operated as below.

Repeat of the current programmed track

Repeat of all programs

Cancel repeat mode
(Program play)

To return to normal play

Press REPEAT several times until OFF is displayed.

REPEATING SECTIONS BETWEEN TWO SPECIFIC POINTS (A-B REPEAT)

1 Press A-B during play at the point where repeat play is to start (A). You can select OFF at this step by pressing CLEAR.

2 Press A-B during play at the point where repeat play is to be concluded (B). Repeat play of the selection between points A and B starts.

To return to normal play

Press A-B once OFF is displayed.

NOTES

- Repeat play works only with discs for which the elapsed playing time appears in the DVD display window during playback.
- Repeat play may not work correctly with some DVDs.
- A-B repeat play works only within a title DVD or a track CD.
- Some subtitles recorded around point A or B may fail to appear (DVD).
- Repeat and Play may not work with MP-3 encoded CD-R and CD-RW.

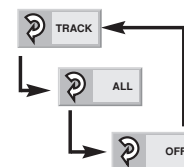
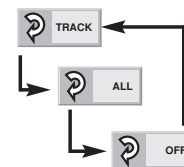
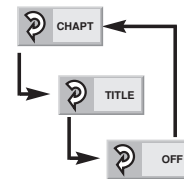

Advanced Operation

STORING MARKERS IN MEMORY TO BE VIEWED (LISTENED TO) AGAIN

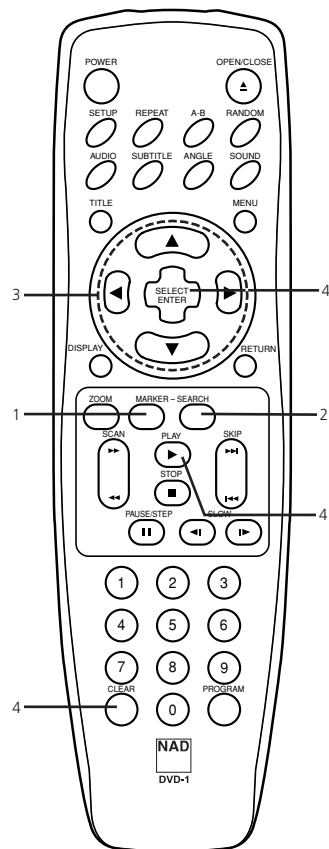

Storing a MARKER in the DVD memory is similar to marking your page in a book. It allows you to quickly return to any point on the disc.

STORING A MARKER IN THE MEMORY

- 1 Press **MARKER** during play at the starting point to be viewed (listened to) again



Indicates 1/5 is stored in the memory.

Up to 5 markers can be stored in the memory.

RECALLING/CLEARING A MARKER

- 2 Press **SEARCH** during playback

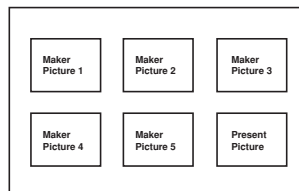

- 3 Press **▲/▼/◀/▶** to select the marker to be recalled/cleared.

- 4 Press **PLAY** or **SELECT/ENTER** to recall a marker. Or press **CLEAR** to clear a marker.

Play resumes from the point corresponding to the selected marker, or the selected marker is cleared.

- The Present Picture is not cleared.

NOTE

- These operations work only with discs for which the elapsed playing time appears in the DVD display window during playback or stop.
- Some subtitles recorded around the marker may fail to appear (DVD).
- All the markers are cleared when the power is turned off or the disc is removed and when TV Aspect mode is changed on the **SETUP** menu.
- The marker is not stored when the DVD or title menu is displayed on the TV screen.

Advanced Operation

DVD VIDEO ZOOM FEATURE

The Zoom feature allows you to ZOOM-IN and enlarge the picture on the screen from normal size to six times normal size.

- 1 Press **ZOOM** during normal playback or still playback.
- 2 If you press **▲/▼/◀/▶** buttons, the zoom point shifts
- 3 Press **SELECT/ENTER**. The selected frame is displayed in full size on the TV screen.
- 4 To resume normal playback. Press **ZOOM** repeatedly until the normal picture is restored.

NOTE

- Some discs may not respond to the Zoom feature.
- Zoom does not work on subtitles or menus included on DVD video discs.

NOTE

- This function only works with audio CD discs. Random does not work with DVD movies.

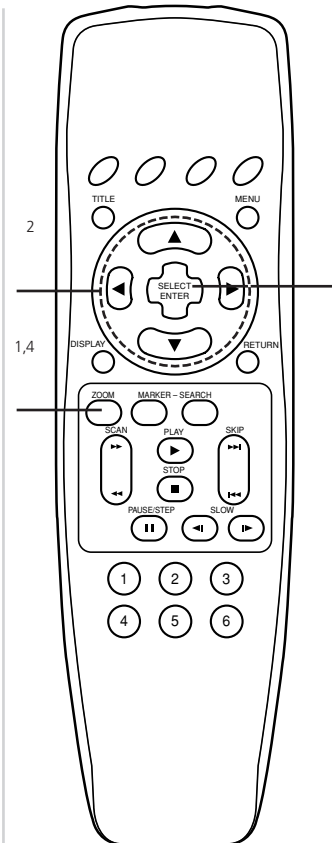

DISC RANDOM PLAY

You can playback titles or tracks in random order. (Random playback)

RANDOM PLAY (CD)

- 1 Press **RANDOM** during normal playback or stop mode. The DVD player automatically starts random playback and the RANDOM indicator in the DVD display window appears.
- 2 To resume normal playback, press **RANDOM**. The RANDOM indicator in the DVD display lights up

NOTE

- Random playback may not be possible on certain discs.
- If you press the **SKIP** **◀◀** or **▶▶** button during random playback, the DVD player goes to another track randomly and starts playback.

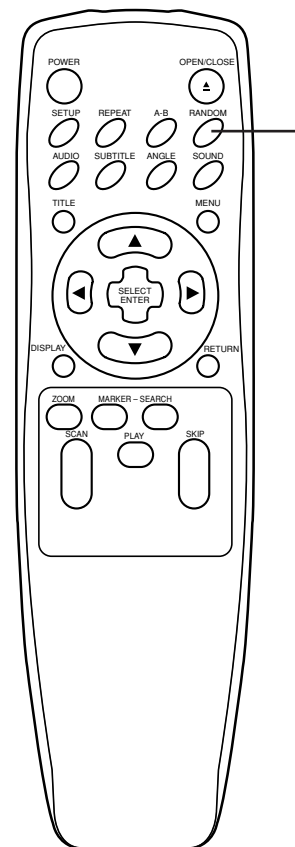
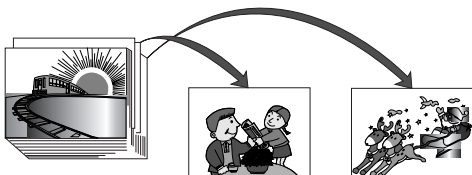

GB

Advanced Operation

PROGRAM PLAY

The player plays the tracks on the disc in the order you specify.

NOTE

- Program play function is possible only with audio CDs. It does not work with DVD movie discs

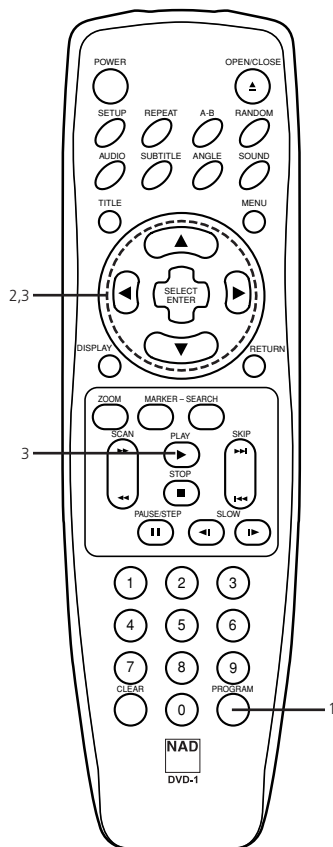

- 1 Press **PROGRAM** during playback or stop mode. The program playback screen appears on the TV screen.

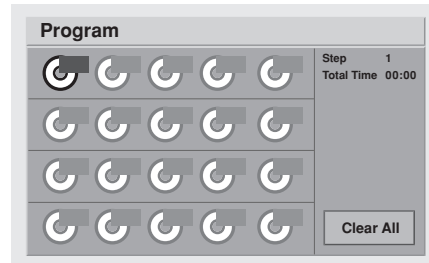

To exit the screen, press **PLAY** or **PROGRAM**.

- 2 Press **▲/▼/◀/▶** and press the numeric button(s) to select the desired track number.



Repeat step 2 to select another track.
Up to 20 tracks can be programmed.

- 3 Press **PLAY** or **SELECT/ENTER** to exit the screen. The selected track is stored in the memory and play now begins in the programmed sequence.
 - If you press **PROGRAM** to exit the screen, the selected tracks are not memorized.

After playback of all tracks programmed

Play is stopped.

CLEARING THE PROGRAM

To clear the programmed tracks one by one

Press **▲/▼/◀/▶** to select the unwanted number and then press **CLEAR**.

To clear all programmed tracks

Press **▲/▼/◀/▶** to select **Clear All** and then press **SELECT/ENTER**. Press **PLAY** or **SELECT/ENTER** to exit the screen. If you press **PROGRAM** to exit the screen, the programs are not cleared. (The programs are also cleared when the power is turned off or the disc removed.)

TO PLAY AN MP3 DISC

- 1 **Load an MP3 disc.** The MP3 menu is displayed.
- 2 Press **▲/▼** buttons to select the directory where MP3 files that you want to play are located and then press **SELECT/ENTER**
- 3 Press **▲/▼** button to select the desired MP3 file of the selected directory of your disc
If you want to return to the previous menu, press the **RETURN** button.
- 4 Press **SELECT/ENTER** or **PLAY** to start playback of the file

FOR YOUR REFERENCE

- Press **SKIP ►►** or **SKIP ◄◄** to play the next file or previous file during playback.
- Press **TITLE** to move to 1st page of current directory during playback and press **TITLE** again to move to the next page within 5 seconds.
- Press **MENU** to move to the Root Directory during playback.

TO PLAY AN MP3 FILE REPEATEDLY

- If you press **REPEAT** button once during play, the current MP3 file will play repeatedly.
- If you press **REPEAT** button twice during play, the directory will play repeatedly.
- If you press **REPEAT** button three times, the repeat play will be cancelled.

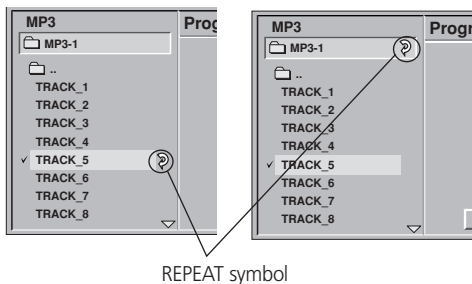

NOTES

- The directory and file name is only displayed in English.
- If there is an impossible code to display, it will be displayed underlined () instead of English.
- If a directory has no MP3 file, the is displayed with the directory name.
- This unit can play up to 256 files per disc. A disc recorded with more than 256 files cannot be played.
- The maximum allowable depth of nested directory is 50.
- Disc format is compatible with ISO9660 only.
- If you record mp3 files using the software which cannot create a FILE SYSTEM, for example Direct-CD etc., it is impossible to playback mp3 files. We therefore recommend that you use Easy-CD Creator, which creates an ISO9660 file system.
- A single session disc requires mp3 files in the first track. If there is no mp3 file in the 1st track, it cannot playback mp3 files. If you wish to playback mp3 files, format all the data in the disc or use a new one.
- If there are already data files which are not mp3 files on the CD-R disc, please, do not use that disc; use a new one instead. However, if the disc is a CD-RW disc, this does not apply.

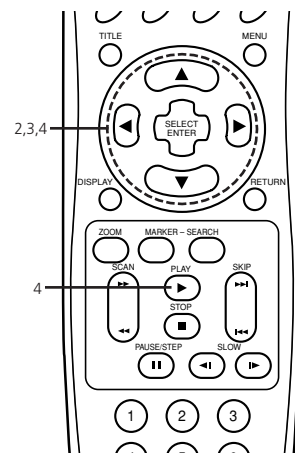
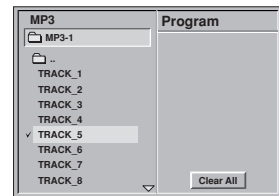
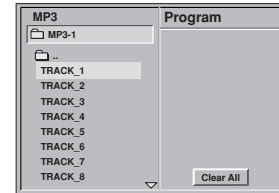
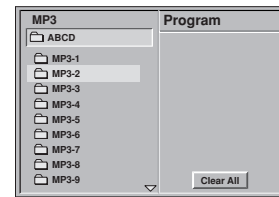

Advanced Operation

PLAYBACK WITH MP3 MP3

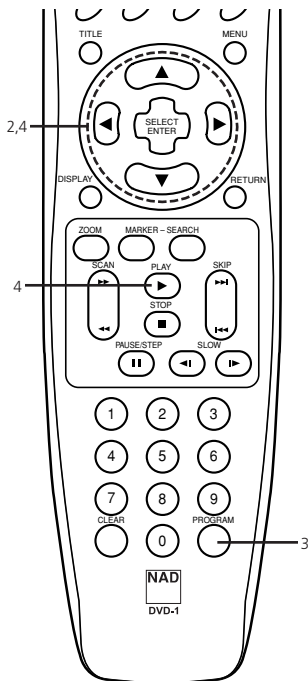
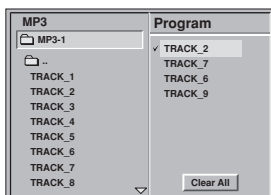
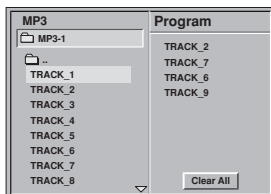
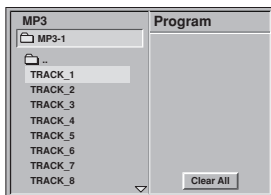

TO PROGRAM PLAY AN MP3 FILE

1 Follow steps 1 and 2 on previous page.

2 Select an MP3 file to program with ▲/▼

3 Press PROGRAM button to add an MP3 file to the program list. Repeat steps 2 - 3 to select another track. Up to 60 files can be programmed.

4 Press ► button and select the desired MP3 file and press SELECT/ENTER or PLAY button to play. If you want to enter the main menu, press ◀ button.

CLEARING THE PROGRAM

To clear the programs one by one

Press ▲/▼/◀/▶ to select the unwanted MP3 file on the program list and then press CLEAR.

To clear all the programs

Press ▲/▼/◀/▶ to select the Clear All and press SELECT/ENTER.

TO PLAY AN MP3 PROGRAM REPEATEDLY

- If you press REPEAT button once during play, the current MP3 file will play repeatedly.
- If you press REPEAT button twice during play, the all MP3 files on the program list will play repeatedly.
- If you press REPEAT button three times, the repeat play will be cancelled.

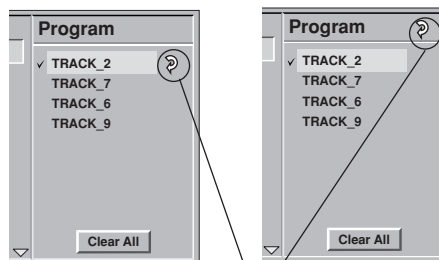



REPEAT symbol

DISC REQUIREMENTS / COPYRIGHT INFORMATION

PLAYABLE DISCS

This DVD player can play back the following discs.

	Disc Mark	Contents	Disc size	Maximum playback time
DVD video discs		Audio+ Video (moving pictures)	12 cm	Approx. 4 hours (single sided disc)
				Approx. 8 hours (double sided disc)
			8 cm	Approx. 80 minutes (single sided disc)
				Approx. 160 minutes (double sided disc)
Audio CDs		Audio	12 cm	74 minutes
			8 cm	20 minutes

In addition this unit can play back a CD-R or CD-RW that contains audio titles or MP3 files

You cannot playback discs other than those listed above. (Video CD CD-ROM, CD-Extra, CD-G, photo CD, and CD-i discs cannot be played on this DVD player.)

REGION MANAGEMENT INFORMATION

Region Management Information: This DVD Player is designed and manufactured to respond to the Region Management Information that is recorded on a DVD disc. If the Region number described on the DVD disc does not correspond to the Region number of this DVD player, this DVD player cannot play that disc.

The Region number of this DVD player is 2.



NOTES ON UNAUTHORIZED DISCS

You may not be able to play back some DVD video discs on this player if they were purchased from outside your geographic area or made for business purposes. When you try to play back an unauthorized disc, **“Check Regional Code”** appears on the TV screen.

NOTES ON COPYRIGHT

It is forbidden by law to copy, broadcast, show, broadcast on cable, play in public, and rent copyrighted material without permission.

DVD video discs are copy protected, and any recordings made from these discs will be distorted.

This product incorporates copyright protection technology that is protected by method claims of certain U.S. patents and other intellectual property rights owned by Macrovision Corporation and other rights owners. Use of this copyright protection technology must be authorized by Macrovision Corporation, and is intended for home and other limited viewing uses only, unless otherwise authorized by Macrovision Corporation. Reverse engineering or disassembly is prohibited.



Reference

BEFORE CALLING SERVICE PERSONNEL

SYMPTOMS AND CORRECTION

Check the following guide for the possible cause of a problem before contacting service.

SYMPTOM	CAUSE	CORRECTION
No power	<ul style="list-style-type: none"> The power cord is disconnected 	<ul style="list-style-type: none"> Plug the power cord into the wall outlet securely.
The power is on, but the DVD player does not work.	<ul style="list-style-type: none"> No disc is inserted. 	<ul style="list-style-type: none"> Insert a disc (Check that the DVD or, audio CD indicator in the DVD display is lit).
No picture	<ul style="list-style-type: none"> The TV is not set to receive DVD signal output. 	<ul style="list-style-type: none"> Select the appropriate video input mode on the TV so that the picture from the DVD player appears on the TV screen.
	<ul style="list-style-type: none"> The video cable is not connected securely. 	<ul style="list-style-type: none"> Connect the video cable into the jacks securely.
	<ul style="list-style-type: none"> The connected TV power is turned off. 	<ul style="list-style-type: none"> Turn on the TV.
No sound	<ul style="list-style-type: none"> The equipment connected with the audio cable is not set to receive DVD signal output. 	<ul style="list-style-type: none"> Select the correct input mode of the audio receiver so you can listen to the sound from the DVD player.
	<ul style="list-style-type: none"> The audio cables are not connected securely. 	<ul style="list-style-type: none"> Connect the audio cable into the jacks securely.
	<ul style="list-style-type: none"> The power of the equipment connected with the audio cable is turned off. 	<ul style="list-style-type: none"> Turn on the equipment connected with the audio cable.
	<ul style="list-style-type: none"> The Digital Audio Output is set to the wrong position. 	<ul style="list-style-type: none"> Set the Digital Audio Output to the correct position, then turn on the DVD player again by pressing the POWER button.
The playback picture is poor	<ul style="list-style-type: none"> The disc is dirty. 	<ul style="list-style-type: none"> Clean the disc.
The DVD player does not start playback	<ul style="list-style-type: none"> No disc is inserted. 	<ul style="list-style-type: none"> Insert a disc (Check that the DVD, or audio CD indicator in the DVD display is lit).
	<ul style="list-style-type: none"> An unplayable disc is inserted. 	<ul style="list-style-type: none"> Insert a playable disc (Check the disc type, color system and Regional code).
	<ul style="list-style-type: none"> The disc is placed upside down. 	<ul style="list-style-type: none"> Place the disc with the playback side down.
	<ul style="list-style-type: none"> The disc is not placed within the guide. 	<ul style="list-style-type: none"> Place the disc on the disc tray correctly inside the guide.
	<ul style="list-style-type: none"> The disc is dirty. 	<ul style="list-style-type: none"> Clean the disc.
	<ul style="list-style-type: none"> A menu is on the TV screen. 	<ul style="list-style-type: none"> Press the SETUP button to turn off the menu screen.
	<ul style="list-style-type: none"> The Rating level is set. 	<ul style="list-style-type: none"> Cancel the Rating function or change the rating level.
The remote control does not work properly.	<ul style="list-style-type: none"> The remote control is not pointed at the remote sensor of the DVD player. 	<ul style="list-style-type: none"> Point the remote control at the remote sensor of the DVD player.
	<ul style="list-style-type: none"> The remote control is too far from the DVD player. 	<ul style="list-style-type: none"> Operate the remote control within about 23 ft (7 m).
	<ul style="list-style-type: none"> There is an obstacle in the path of the remote control and the DVD player. 	<ul style="list-style-type: none"> Remove the obstacle.
	<ul style="list-style-type: none"> The batteries in the remote control are exhausted. 	<ul style="list-style-type: none"> Replace the batteries with new ones.

DVD PLAYER / OUTPUTS / SUPPLIED ACCESSORIES**DVD PLAYER**

Power supply	AC 110-240V, 50/60Hz
Power consumption	14 W
Mass	2.8 kg
External dimensions (W X H X D)	430 x 75.6 x 242 mm 16.9 x 3.0 x 9.5 inches
Signal system	PAL 625/50 , NTSC 525/60
Laser	Semiconductor laser, wavelength 650 nm
Frequency range (audio)	DVD: (PCM 96 kHz) 4 Hz to 22 kHz DVD: (PCM 96 kHz) 4 Hz to 44 kHz CD: 4 Hz to 22 kHz
Signal-to-noise ratio (audio)	More than 100 dB (EIAJ) (ANALOGUE OUT only)
Dynamic range (audio)	DVD: More than 100 dB (EIAJ) (ANALOGUE OUT only) CD: More than 95 dB (EIAJ) (ANALOGUE OUT only)
Harmonic distortion (audio)	0.008 %
Operating conditions	Temperature: 5°C to 35°C, Humidity 5% to 90%
Operation status	Horizontal

OUTPUTS

Video output	1.0 V (p-p), 75Ω, negative sync., RCA jack x 1/SCART
S-video output	(Y) 1.0 V (p-p), 75Ω, negative sync., Mini DIN 4-pin x 1 (C) 0.3 V (p-p), 75Ω
Audio output (digital audio)	0.5 V (p-p), 75Ω, RCA jack x 1
Audio output (optical audio)	Optical connector x 1
Audio output (analog audio)	2.0 Vrms (1 kHz, 0 dB), 330Ω, RCA jack (L, R) x 1/SCART

SUPPLIED ACCESSORIES

Video cable	1
Audio cable	1
Remote control	1
Batteries	2

- *Designs and specifications are subject to change without notice.*

Manufactured under license from Dolby Laboratories. "Dolby", and the double-D symbol are trademarks of Dolby Laboratories. Confidential unpublished works. Copyright 1992-1997 Dolby Laboratories. All rights reserved.

"DTS" and "DTS Digital Out" are trademarks of Digital Theater Systems, Inc.



www.NADelectronics.com

**©2002 NAD ELECTRONICS INTERNATIONAL
A DIVISION OF LENBROOK INDUSTRIES LIMITED**

All rights reserved. No part of this publication may be reproduced, stored or transmitted in any form without the written permission of NAD Electronics International

T532 Manual 08/02